



Lens Control System Instruction Manual

As of: July 2000

ALL ARTWORK, PICTURES AND TEXTS ARE COVERED BY OUR COPY-RIGHT.

THEY MUST NOT BE COPIED FOR REPRODUCTION (E.G. ON CD-ROM DISKS OR INTERNET-SITES) OR USED IN THEIR ENTIRE FORM OR IN EXCERPTS WITHOUT OUR PREVIOUS WRITTEN AGREEMENT.

IF YOU ARE DOWNLOADING PDF-FILES FROM OUR INTERNET HOME-PAGE FOR YOUR PERSONAL USE, MAKE SURE TO CHECK FOR UPDATED VERSIONS.

WE CANNOT TAKE ANY LIABILITY WHATSOEVER FOR DOWNLOADED FILES, AS TECHNICAL DATA ARE SUBJECT TO CHANGE WITHOUT NOTICE.

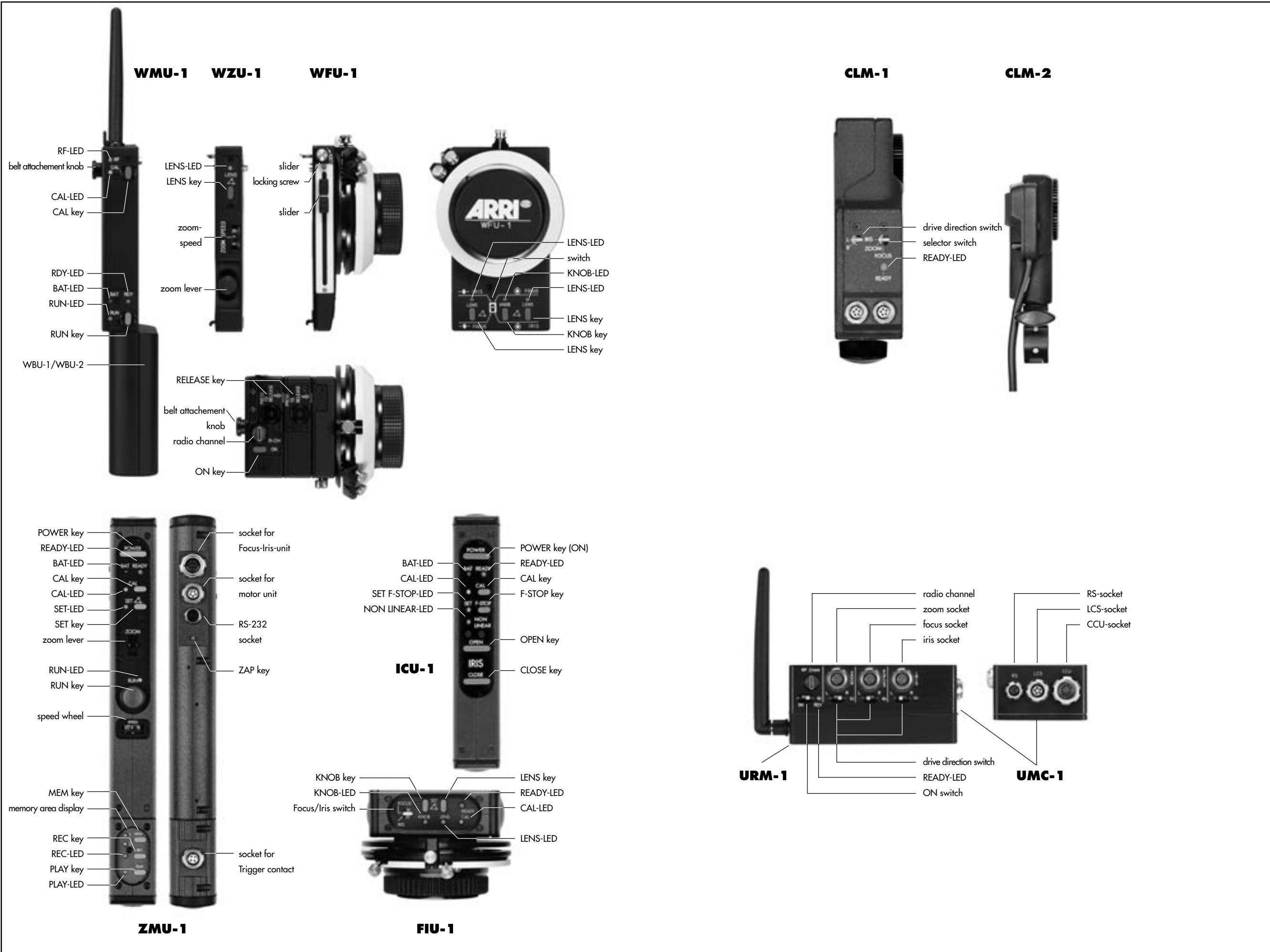

1. Contents

1. Contents	3	ICU-1 Iris Control Unit	15
2. Safety Specifications	7	Power Supply	15
3. The System	9	Cables	15
3.1 Easy Electronic Lens Control	9	Diagram System Overview	16
3.2 System Components	9	3.3 System Overview	17
CLM-1 Controlled Lens Motor	11	3.3.1 Motor Units	17
CLM-2 Controlled Lens Motor	11	3.3.2 Manual Control Units	17
UMC-1 Universal Motor Controller	11	3.4 Typical Examples of Use	18
URM-1 Universal Radio Module	11	3.4.1 Radio remote control of focus	18
WMU-1 Wireless Main Unit	13	3.4.2 Control of all three lens rings via radio	19
WBU-1/WBU-2 Wireless Battery Unit	13	3.4.3 Control of the zoom ring via cable	20
WAC-1 Wireless Accumulator Charger	13	3.4.4 Control of the zoom ring via cable	
WZU-1 Wireless Zoom Unit	13	and focus via radio	21
WFU-1 Wireless Focus Unit	13	3.4.5 Control of all three lens rings via cable	22
WEU-1 Wireless Extension Unit	13		
ZMU-1 Zoom Main Unit	15		
FIU-1 Focus Iris Unit	15		

4. Setup	23	5. Operation	35
4.1 Installing and Connecting the Lens Motors ..	23	5.1 Radio Remote Control	35
4.1.1 Selection of lens motors and their power supply	23	5.1.1 Manual control units for radio remote control	35
4.1.2 Attaching and connecting the motors	26	5.1.2 Operating the WMU-1 (Wireless Main Unit) ..	36
4.2 Attaching and Connecting the Manual Control Units	33	5.1.3 Operating the WZU-1 (Wireless Zoom Unit) ..	47
		5.1.4 Operating the WFU-1 (Wireless Focus Unit) ...	50
		5.1.5 Operating several units	56
		5.1.6 Radio Unit accessories	57
		5.2 Remote Control via Cable	61
		5.2.1 Manual control units for remote control via cable	61
		5.2.2 Operating the ZMU-1 (Zoom Main Unit) ..	61
		5.2.3 Operating the FIU-1 (Focus Iris Unit)	68
		5.2.4 Memory Module	72
		5.2.5 Trigger Function	75
		5.2.6 ICU-1 (Iris Control Unit)	77

6. Mechanical Accessories	97	7. Trouble-Shooting	105
6.1 Mounting on Ø 15mm Support Rods	97	7.1 Power Supply	105
Replace the offset clamp unit		7.2 UMC-1 Universal Motor Controller LEDs ...	106
on the CLM-1	97	7.3 CLM-1 Motor Unit LEDs	107
Mounting diminishing brackets		7.4 WMU-1 Wireless Main Unit LEDs	108
on the motor unit CLM-2	98	7.5 WZU-1 Wireless Zoom Unit LEDs	110
Mounting the diminishing brackets		7.6 WFU-1 Wireless Focus Unit LEDs	111
on the console	98	7.7 ZMU-1 Zoom Main Unit LEDs	112
6.2 Offset Mounting	100	7.8 FIU-1 Focus/Iris Unit LEDs	114
6.3 Panhandle Holer	101	7.9 ICU-1 Iris Control Unit LEDs	115
6.4 Motor Holder or ARRIFLEX 35 III	101	8. Index	117
Mounting the motor holder	101	9. Technical Data	125
6.5 Movable Irisrive Gear	102	Description of System Components	125
Mounting the Movable Iris Drive Gear ...	102	Power Supply	125
6.6 Iris Drive Gar	103	Torque of Motor Unit	126
6.7 Iris Gear Ris	103	Weight	126
		Operating Noise Level	126
		Temperature Range	126
		Memory Module	126
		Iris Control Unit ICU-1	127
		10. ARRI Service	128

2. Safety Specifications

- The Lens Control System – LCS – has been thoroughly tested for quality of workmanship and operating functions before leaving the factory.
- To ensure optimal performance, it is essential that you acquaint yourself with this instruction manual.
- Set-up and operation of the LCS unit should only be carried out by persons who are familiar with the equipment!
- In wet weather the usual precautions for use of electrical equipment must be taken!
- Do not use solvents to clean the LCS!
- Do not loosen any screws which are painted over!
- Use only original ARRI spare parts and accessories!
- Repairs must only be carried out by authorised professionals!



As the end-stops of the iris ring on the ARRIMACROS change when the lens is focussed, the ARRIMACROS may not be used with the LCS or the WRC-1 system.

Meaning of the symbols in this user manual

⇒ **photo** indicates objects which are shown in the illustration.

- Warning indications:



*Caution! - means injury possible
Attention! - means damage to equipment possible*

Note: Further information or indications of possible incorrect operation.

Product Identification

When ordering parts or accessories, or if any questions should arise, please advise your type of product and serial number.



3. The System

3.1 Easy Electronic Lens Control

The ARRI Lens Control System – LCS – is an easy-to-use remote control system for camera lenses. A compact, modular system that can be expanded from simple zoom control to a complete remote-control system for zoom, focus and iris. It can be operated via radio or remotely controlled via a cable. The system covers all control possibilities for standard lenses for ARRIFLEX cameras and can also be used on cameras from other manufacturers.

The user can adapt the LCS with its varied functions to his own needs, for example adjustment range and speed as well as transmission ratio – at the touch of a button.

With the optional memory module programs and settings can be stored and repeated.

3.2 System Components

All operations of the lens control system can be performed with the flexible individual units. In general, all units are abbreviated using a code with three letters, a hyphen and a number (e.g. CLM-1). All cables are abbreviated using a code with two letters, a hyphen, a letter and a number (e.g. UC-C1). The Lens Control System consists of the following units:



CLM-1



CLM-2



UMC-1

URM-1

CLM-1 Controlled Lens Motor

The main features of the motor units CLM-1 ⇨ **photo** are their high torque; they are particularly suited to work with stiff lenses or in cold weather. The vertical mounting allows the motor unit to be attached even when the available space for the set-up is restricted. The motor units can be installed on and removed from the fully equipped camera. The matte box does not need to be removed.

CLM-2 Controlled Lens Motor

The small, lightweight motor units CLM-2 ⇨ **photo** are particularly suited to applications for which weight and size are decisive factors, for example Steadicam shots, when using 16mm or video cameras, or with sensitive lenses. As with the CLM-1 motor units the vertical mounting enables working in particularly tight conditions. The consoles to the motors enable very flexible mounting. To use a CLM-2 motor, the universal motor controller UMC-1 is necessary.

UMC-1 Universal Motor Controller

The universal motor controller UMC-1 ⇨ **photo** is used to control the CLM-2 motors on the camera. Up to three CLM-2 motors (zoom, focus, iris) can be controlled. Mixed operation with CLM-1 and CLM-2 motors is also possible.

URM-1 Universal Radio Module

The Universal Radio Module URM-1 ⇨ **photo** is mounted to the UMC-1 and provides the radio connection to the WMU-1.



WMU-1

WZU-1 WFU-1



WMA-1

WCE-1

WHA-1



WAC-1

WMU-1 Wireless Main Unit

The WMU-1 ⇨ **photo** is the central main unit for radio remote control and provides the radio connection from the manual control units to the URM-1. With the WMU-1 various manual control units (WZU-1, WFU-1) can be combined to remotely control the lens and camera. Three WMU-1 can be operated simultaneously with the system.

WBU-1/WBU-2 Wireless Battery Unit

The battery WBU-1/WBU-2 ⇨ **photo** is used to power the WMU-1.

WAC-1 Wireless Accumulator Charger

The Battery Charger WAC-1 ⇨ **photo** is used to charge the WBU-1 battery.

WZU-1 Wireless Zoom Unit

The wireless zoom control unit WZU-1 ⇨ **photo** can be attached to the WMU-1 to enable wireless remote control of the focal length on a zoom lens.

WFU-1 Wireless Focus Unit

The wireless focus control unit WFU-1 ⇨ **photo** can be attached to the WMU-1 to enable radio remote control of the lens iris and focus.

WEU-1 Wireless Extension Unit

The extension WEU-1 ⇨ **photo** consists of three components which enable the WMU-1 to be worn on a belt so that only the manual control unit needs to be held: the adapter WHA-1 (Wireless Handgrip Attachment), ⇨ **photo**, the cable WC-E1 ⇨ **photo** and the WMA-1 (Wireless Main Attachment) ⇨ **photo**.



ZMU-1



FIU-1



ICU-1

ZMU-1 Zoom Main Unit

The zoom unit ZMU-1 ⇨ **photo** is the main control unit for all configurations remotely controlled via cable. It enables the focal length of zoom lenses to be adjusted by remote control.

FIU-1 Focus Iris Unit

The focus iris unit FIU-1 ⇨ **photo** can be used for remote focus as well as remote iris control. It is user-friendly and can be operated on the same principles as the mechanical follow-focus system. To use an FIU-1, a ZMU-1 is always necessary.

ICU-1 Iris Control Unit

The ICU-1 ⇨ **photo** provides constant exposure during speed-ramps. It constantly monitors the frame rate of the camera. During a frame rate change, the ICU-1 will calculate a new value for the iris to compensate for the exposure change, and instruct the lens motor to change the iris ring accordingly.

Power Supply

The LCS is operated with a separate 24V or 12V battery. The LCS can also be powered directly from the camera, provided the rated load of the camera socket is not exceeded.

Cables

A modular cable-connecting system allows easy connection from one unit to the other, as well as to the system operating control. The LCS recognises connected units and also detects defective cables.

Diagram System Overview

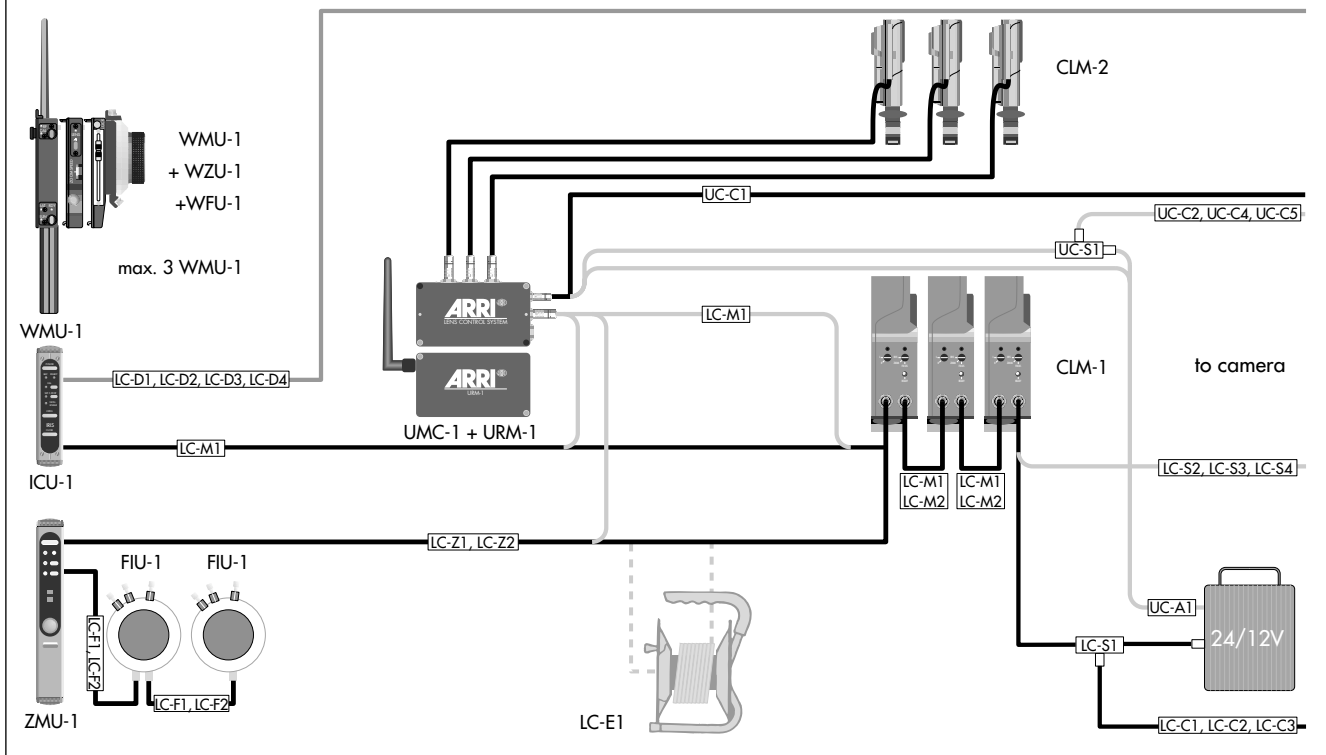

3.3 System Overview

The illustration on the left page provides an overview of the entire system with the various units, their relation to each other, and which cables are used to connect the units. For typical examples of use please see the following pages.

With the various manual control units, up to 3 lens motors can be controlled via cable or radio. The camera can be started or stopped with the units

- ZMU-1 (Zoom Main Unit) (via cable)
- and WMU-1 (Wireless Main Unit) (via radio).

3.3.1 Motor Units

The LCS enables a maximum of three lens motors to be controlled via the manual control units. The CLM-1 motors are particularly useful for stiff lenses, they can be operated with either a power cable LC-S1 (S2, S3, S4) or the UMC-1. The CLM-2 motors are particularly useful for configurations in restricted spaces or if weight is critical. The CLM-2 motors can only be operated together with the UMC-1.

3.3.2 Manual Control Units

Remote Control via Cable

For remote control via cable the ZMU-1 is always necessary. It is either connected to the UMC-1 or a CLM-1 motor. If iris and/or focus are to be controlled, up to two Focus Iris Units FIU-1 can be attached to the ZMU-1.

Remote Control via Radio

To remotely control via radio at least one WMU-1 is always necessary. A maximum of three WMU-1 can be operated simultaneously. For the lens motors a UMC-1 with an attached URM-1 is always necessary. On the WMU-1 units can be attached to control the lens zoom ring with the WZU-1, or to control the focus ring and/or iris ring with the WFU-1. All three lens rings can be remotely controlled with one WMU-1 or with several WMU-1 units in radio network operation.

3.4 Typical Examples of Use

3.4.1 Radio remote control of focus

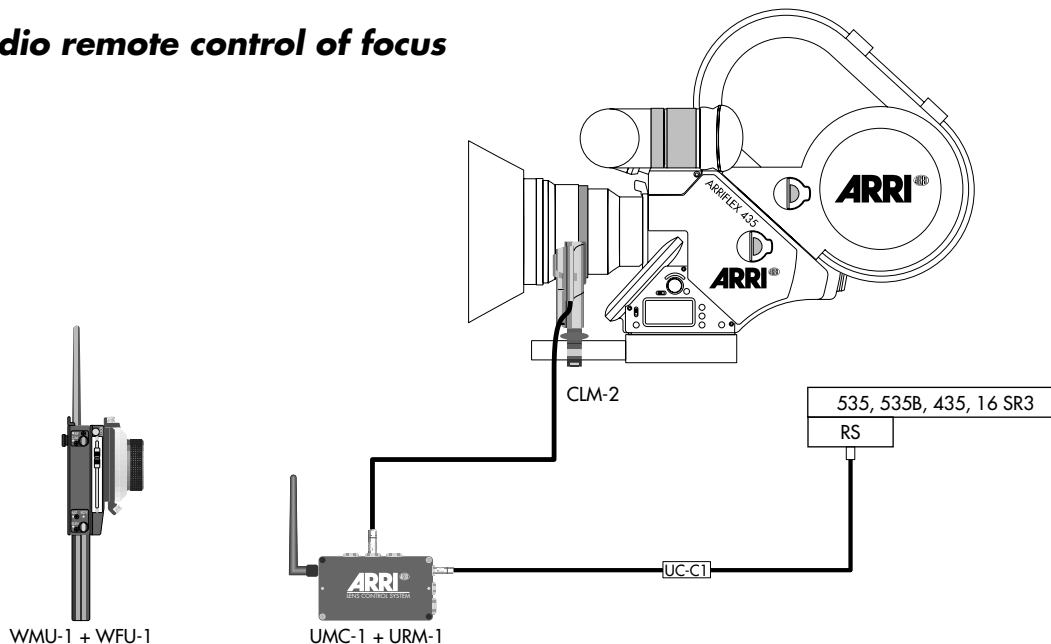

3.4.2 Control of all three lens rings via radio

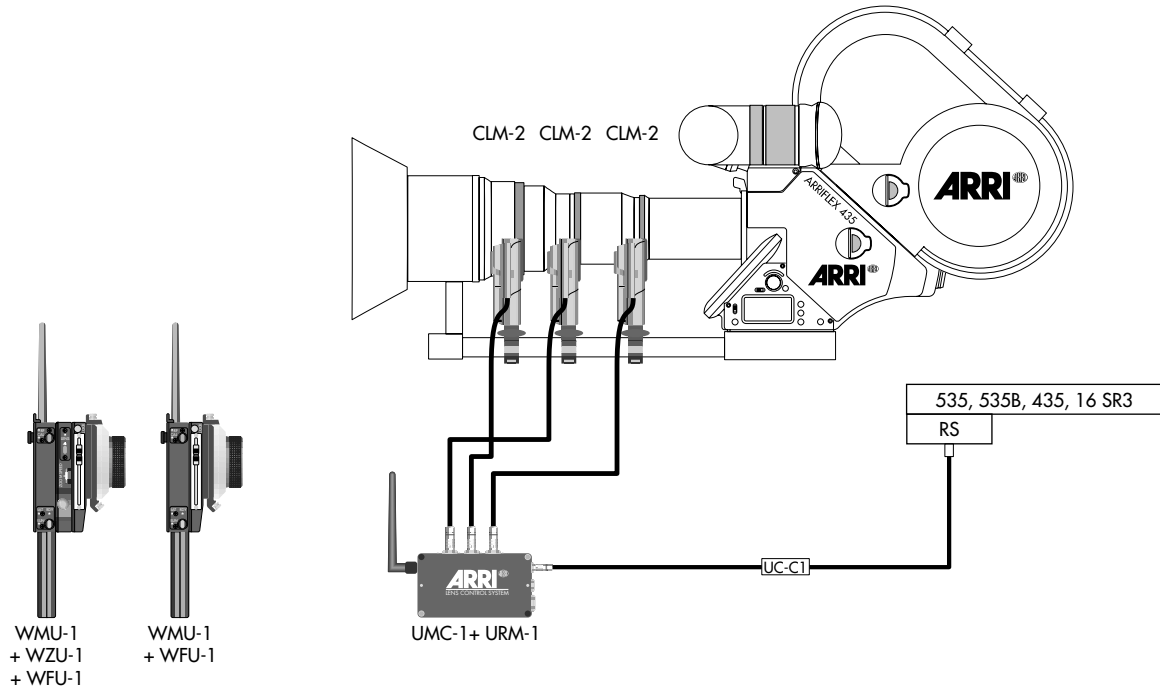

3.4.3 Control of the zoom ring via cable

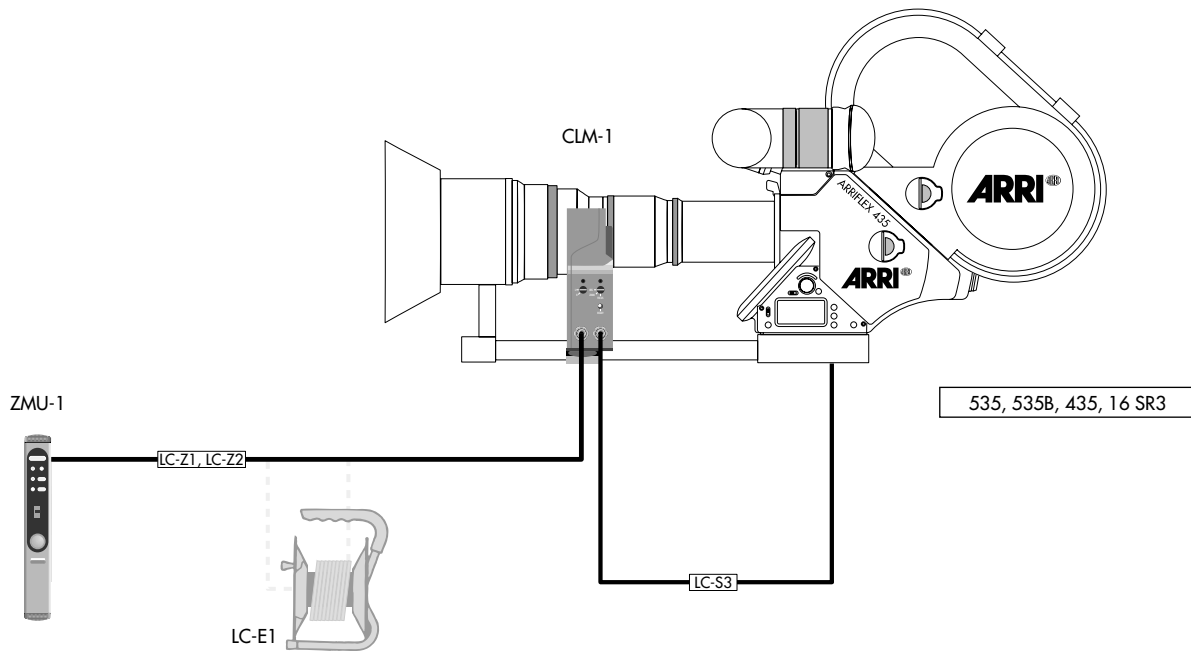

3.4.4 Control of the zoom ring via cable and focus via radio

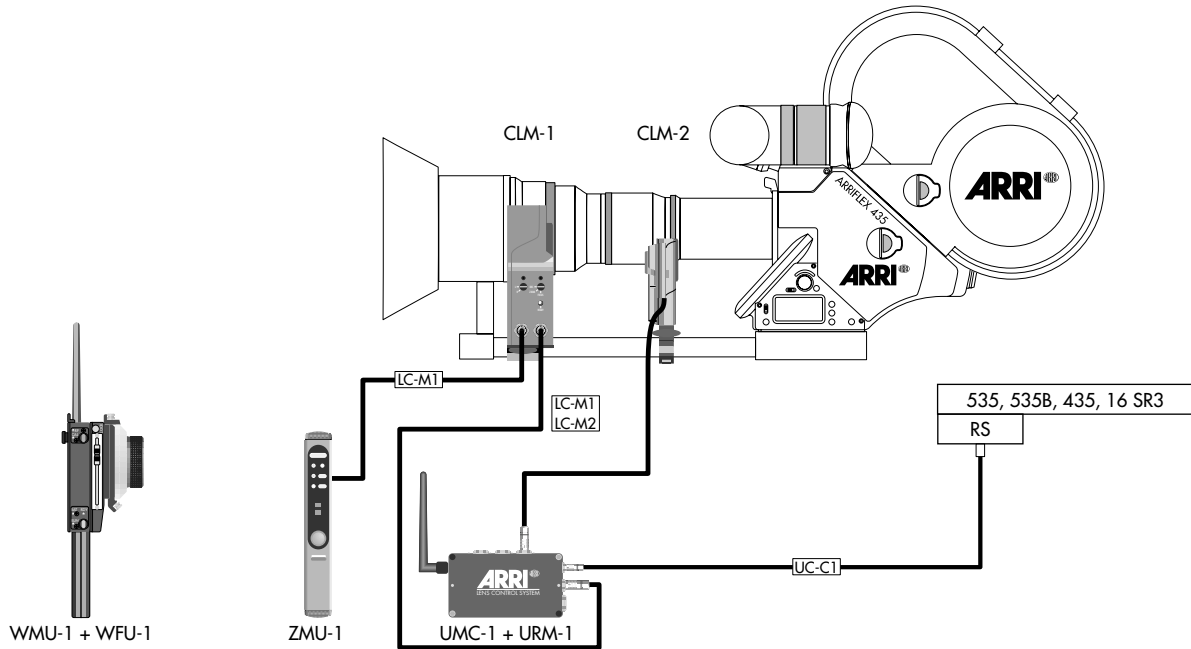

3.4.5 Control of all three lens rings via cable

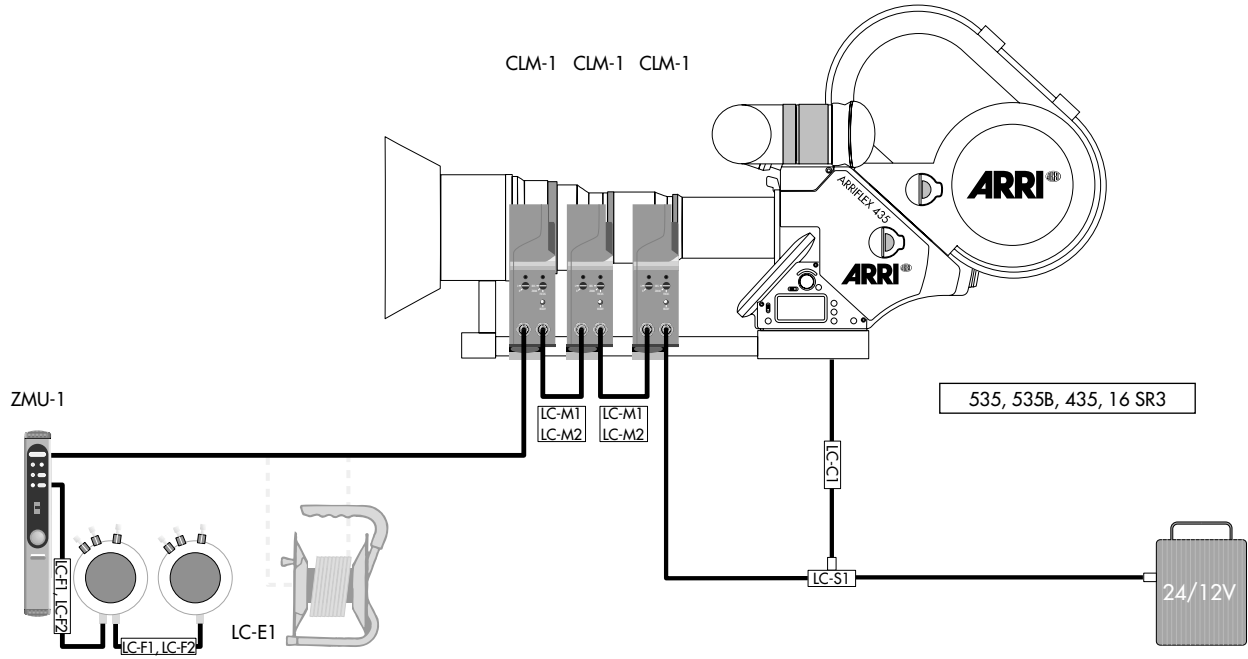

4. Setup

4.1 Installing and Connecting the Lens Motors



Before connecting or disconnecting electrical connections, switch off

- *the Zoom Main Unit ZMU-1,*
- *the Universal Motor Controller UMC-1*
- *and all Wireless Main Units WMU-1!*



*Use only 24V or 12V batteries!
Changing the setting is not necessary. The LCS automatically recognises the voltage.
At 12V there is however a lower maximum speed of the lens motors due to the lower torque.*



As the end-stops of the iris ring on the ARRIMACROS change when the lens is focussed, the ARRIMACROS may not be used with the LCS or the WRC-1 system.

4.1.1 Selection of lens motors and their power supply

There are two different lens motors available:
The lens motors CLM-1 have a high torque and should be used with stiff lenses or in adverse weather conditions.

The lens motors CLM-2 are lighter and smaller. Where light weight and small size are important, they should be used.

For various lens rings, different motor types can also be used, for example a CLM-1 motor for the zoom ring and a CLM-2 motor for the iris ring.

After selecting the control motors, the power supply for them must be specified. The selection can be made according to the diagram on the **fold out page** in the back of this manual. In the squares is listed which units and cables are necessary for the desired application.

The cables listed in the diagram should be connected to the various units according to the following table:

To power from the battery

<i>Code</i>	<i>Description</i>	<i>Connection between</i>	<i>Length / m</i>	<i>Plug with no. pins</i>	
UC-A1	Power cable UMC-1	Battery / UMC-1 or UC-S1	2	XLR 3*	Fischer3
LC-S1	Power cable CLM-1	Battery / CLM-1	4.5	XLR 3*	Fischer5
LC-A1	Battery cable	Battery / Power cable	0.15	XLR 4*	XLR 3*
LC-A2	Battery cable	Battery / Power cable	0.15	XLR 5*	XLR 3*

For remote RUN and to power from the camera

<i>Code</i>	<i>Description</i>	<i>Connection between</i>	<i>Length / m</i>	<i>Plug with no. pins</i>	
UC-C1	Supply UMC-1 from 435, 535, 535B, 16SR3	Camera / UMC-1	1	Fischer3	Fischer3
LC-S2	Supply CLM-1 from 435, 35III, 35BL, 16SR2	Camera / CLM-1	0.8	Fischer11	Fischer5
LC-S3	Cable CLM-1 from 435+FEM, 535, 535B, 16SR3	Camera / CLM-1	0.8	Fischer9	Fischer5

For remote RUN when using a UMC-1 as well as to power from the camera or a battery

<i>Code</i>	<i>Description</i>	<i>Connection between</i>	<i>Length / m</i>	<i>Plug with no. pins</i>	
UC-S1	UMC-1 Connection with UC-C2 C4, C5 cable to the camera and connection to the battery with UC-A1	RUN cable and battery / UMC-1	0.8	Fischer7 and 3 Fischer3	
UC-C2	RUN cable with 435, 35III, 35BL, 16SR11	Camera / UC-S1	1	Fischer11	Fischer7
UC-C4	RUN cable with 535, 535B, 435+FEM, 16SR3	Camera / UC-S1	1	Fischer9	Fischer7
UC-C5	RUN cable 535B, 435, 16SR3	Camera / UC-S1	1	Fischer3	Fischer7

For remote RUN when using an LC-S1

<i>Code</i>	<i>Description</i>	<i>Connection between</i>	<i>Length / m</i>	<i>Plug with no. pins</i>	
LC-C1	RUN cable with 435+FEM, 535, 535B, 16SR3	Camera / LC-S1	1	Fischer9	Fischer6
LC-C2	RUN cable with 435, 35III, 35BL, 16SR2	Camera / LC-S1	1	Fischer11	Fischer6 and XLR 3*

To cable the cable manual control units

<i>Code</i>	<i>Description</i>	<i>Connection between</i>	<i>Length / m</i>	<i>Plug with no. pins</i>	
LC-M1	Motor cable	CLM-1 / CLM-1	1	Fischer5	Fischer5
LC-M2	Motor cable	CLM-1 / CLM-1	0.2	Fischer5	Fischer5
LC-Z1	Zoom cable	ZMU-1 / CLM-1	3.5	Fischer5	Fischer5
LC-Z2	Zoom cable	ZMU-1 / CLM-1	7	Fischer5	Fischer5
LC-E1	Zoom cable extension	LC-Z1 or LC-Z2 / CLM-1	75	Fischer5	Fischer5
LC-F1	Focus cable	ZMU-1 or FIU-1 / FIU-1	2	Fischer10	Fischer10
LC-F2	Focus cable	ZMU-1 or FIU-1 / FIU-1	0.2	Fischer10	Fischer10

*) Assignment of pin contacts

Type		pins	Assignment
XLR	3-pin	1	Ground
		2	+ 24V or + 12V DC
XLR	4-pin	1	Ground
		4	+ 24V or + 12V DC
XLR	5-pin	1	Ground
		3	+ 24V or + 12V DC

If the LCS is to be powered by a camera from another manufacturer, the relevant information should be obtained from that manufacturer.

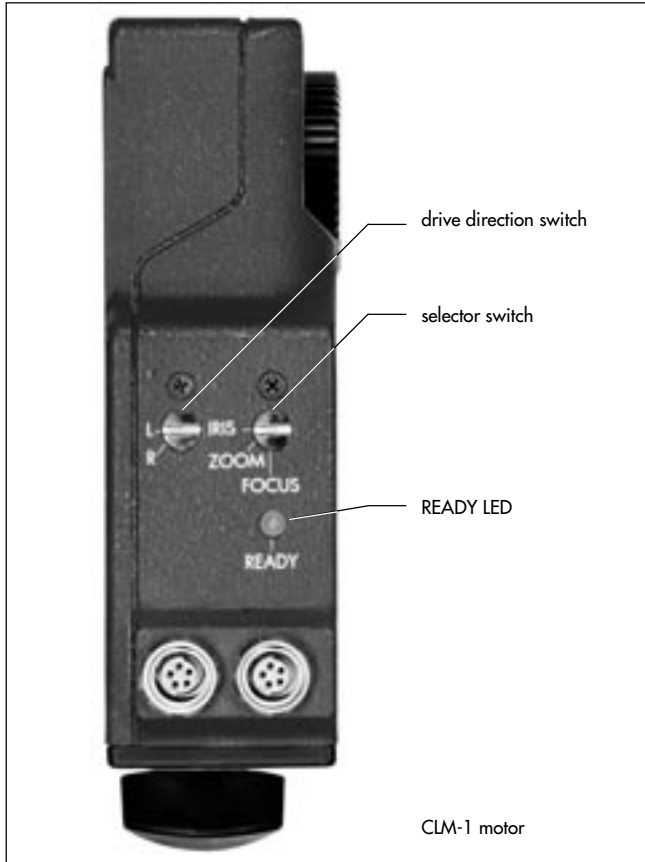

4.1.2 Attaching and connecting the motors

Attaching the motor unit CLM-1

- Clamp the motor unit CLM-1 ⇨ **photo** on the lens support rods. Make sure the motor unit's drive gear engages the lens' gear. Ensure as little play as possible!
- Lenses with laterally moving gears: with the motor unit engaged, turn the lens ring manually through its entire range to ensure perfect movement. Do not press the motor too hard in order to prevent tilting of the shift unit.
- Turn the selector switch ⇨ **photo** on the motor unit to position corresponding to the lens ring
- Select the drive direction with the switch (L/R) ⇨ **photo** on the motor unit CLM-1.

Note: The operating direction of the motor unit can be altered at any time (except during the calibration process).

- When using an LC-S1 cable, connect the first motor with the LC-S1 and additional CLM-1 motors to each other with LC-M1 or LC-M2 cables.
- When using a UMC-1, connect the first motor with an LC-M1 or LC-M2 cable to the LCS-socket on the UMC-1. Connect the additional CLM-1 motors to each other with LC-M1 or LC-M2 cables.



CLM-1 motor mounted at an ARRIFLEX 35 III

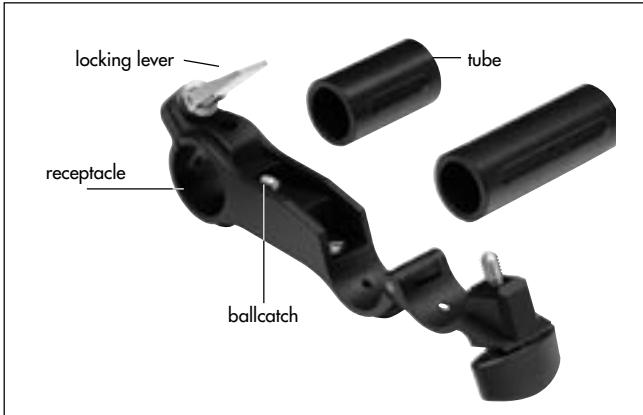

Mounting the CLM-2 with /without a console

Order number of the console: K2.52035.0

- Flip up the locking lever ⇨ **photo** and screw back the ballcatch ⇨ **photo** with a screwdriver until it disappears completely in the bracket.
- Push the tube ⇨ **photo** flush into the console receptacle, taking care that the slit in the tube points towards the ballcatch.
- Screw the ballcatch out of the bracket until the tube can no longer be pushed out of the bracket.
- Turn the locking lever until a slight resistance can be felt, then press the lever downwards.
- Fasten the motor unit CLM-2 to the console tube.

- Fasten the console to the support rods so that the motor unit's drive gear engages with the gear of the lens ring. Ensure as little play as possible!
- Lenses with laterally moving gears: with the motor unit engaged, turn the lens ring manually through its entire range to ensure perfect movement. Do not press the motor too hard in order to prevent tilting of the shift unit.

The motor unit CLM-2 can also be mounted directly onto the support rods without the console.



assembly with console

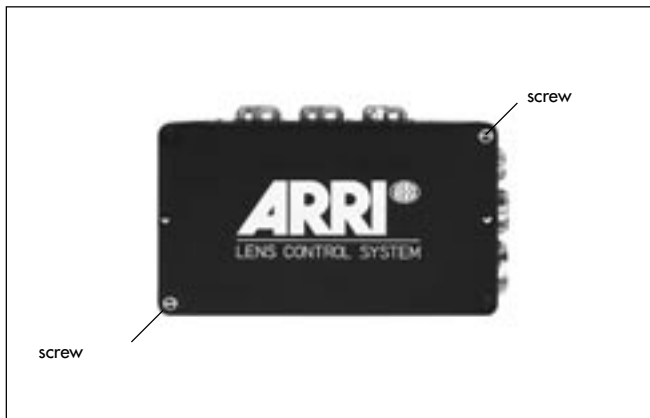
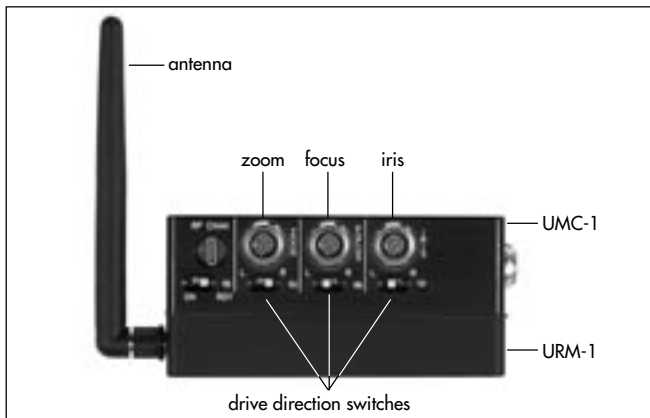

- Attach the plug of the motor unit CLM-2 to the socket ⇨ **photo** of the universal motor controller UMC-1 which corresponds to the lens ring.
- Select the drive direction with the switch (L/R) ⇨ **photo** on the universal motor controller UMC-1.

Note: The operational direction of the motor can be altered at any time (except during the calibration process).

Attaching the URM-1 (Universal Radio Module) to the UMC-1 (Universal Motor Controller)

For radio operation the UMC-1 ⇨ **photo** must be equipped with a URM-1 ⇨ **photo**.

- Remove all cables from the UMC-1.
- Screw the antenna ⇨ **photo** onto the threaded bushing on the URM-1.
- Unscrew both screws ⇨ **photo** from the cover and remove the cover.

- Place the URM-1 onto the UMC-1, align both plugs ⇨ **photo** with each other and do not tilt them while attaching.
- Screw the URM-1 tight to the UMC-1 with the two screws.

Attaching the UMC-1/URM-1 to the camera

- Attach the universal motor controller UMC-1 ⇨ **photo** to the camera using the dovetail adapter with a 3/8" thread (Ident-No. K2.52080.0).

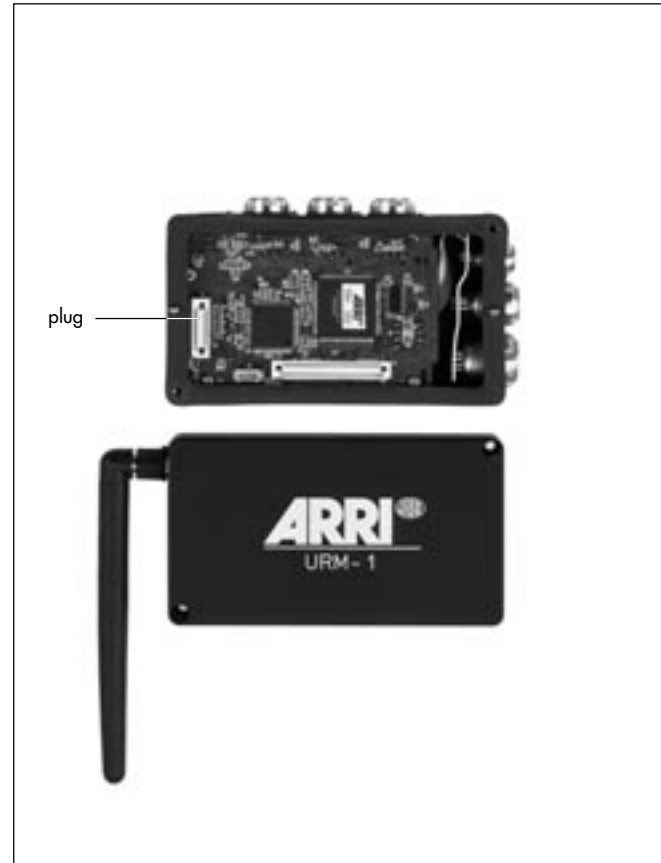



4.2 Attaching and Connecting the Manual Control Units

After cabling up the motors and their power supplies, it is necessary to define which manual control units will be used to control the motors. The selection can be made using the diagram on ⇨ **the fold-out page** in the back of this manual. In the squares is listed which units and cables are necessary for the desired application.

Connect the cables listed in the diagram with the different units according to the following table:

To cable the cable manual control units					
Code	Description	Connection between	Length / m	Plug with no. pins	
LC-Z1	Zoom cable	ZMU-1 / CLM-1	3.5	Fischer5	Fischer5
LC-F1	Focus cable	ZMU-1 or FIU-1 / FIU-1	2	Fischer10	Fischer10
LC-F2	Focus cable	ZMU-1 or FIU-1 / FIU-1	0.2	Fischer10	Fischer10

Note: The focus iris unit FIU-1 cannot be used together with a WFU-1 in radio operation.

Note: The zoom cable LC-Z1 can be extended by 75 m with the cable drum LC-E1.

WMU-1



WZU-1



WFU-1



5. Operation

5.1 Radio Remote Control

5.1.1 *Manual control units for radio remote control*

In general for remote control via radio always at least one WMU-1 (Wireless Main Unit) ⇨ **photo** is necessary as a radio main unit. As a maximum, three WMU-1 can be operated simultaneously. A UMC-1 (Universal Motor Controller) with a URM-1 (Universal Radio Module) must be used to control the motors on the camera.

Through the flexible design of the system, optimal manual operations for radio remote control can be created as desired. It is possible to remotely control the various setting rings on a lens as desired with a single or up to three WMU-1 radio remote controllers in radio network operation.

General features

Two units can be attached to the WMU-1 to remotely control the lens:

- the WZU-1 (Wireless Zoom Unit) ⇨ **photo** to remotely control the zoom ring.
- the WFU-1 (Wireless Focus Unit) ⇨ **photo** to remotely control the focus and/or iris ring.

Both units can be attached together to the WMU-1; the WZU-1 is then attached first and then the WFU-1 onto the WZU-1.

5.1.2 Operating the WMU-1 (Wireless Main Unit)

5.1.2.1 Selecting the radio channel

On the WMU-1 and the UMC-1, various radio channels can be set. So that one or more WMU-1 units (maximum: three) and one UMC-1 will work with each other, these must all be set to the same radio channel.

If several lenses are to be remotely controlled independently of each other, each UMC-1 used must be set to a different channel. The following radio channels can not be used simultaneously:

- radio channel 0 and 5
- radio channel 1 and 6
- radio channel 3 and 7.

It is not possible to control two UMC-1 units with one manual unit.



Due to local telecommunications regulations, only certain channels are allowed in some countries. Only the channels listed in the following table may be set!

Switch setting	Countries
0	USA, Canada, Mexico, New Zealand, Europe except France and Spain
1	USA, Canada, Mexico, New Zealand, Europe except France and Spain
2	Europe except Spain
3	USA, Canada, Mexico, New Zealand, France
4	Japan
5	Australia
6	Australia
7	Spain
8,9	see switch setting 0

In all countries not listed in this table, radio channels from 0-7 may be programmed if there are no local telecommunication restrictions for the 2.4 GHz band.

- Set the desired channel with the rotary selection knob
⇒ **photo** on the URM-1.
- Using the selection knob on the WMU-1 (Wireless Main Unit/s) , set the same channel as on the URM-1.

Note: As an alternative to the wireless control a cable WC-A1 (15m, other lengths upon request) (K2.52081.0) can be attached to the antenna sockets instead of the two antennas (sender and receiver).

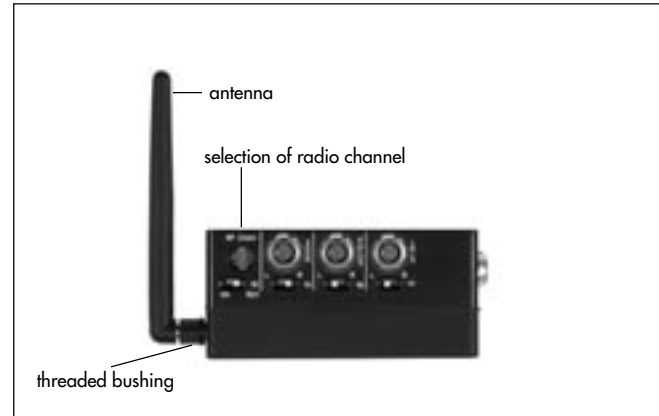

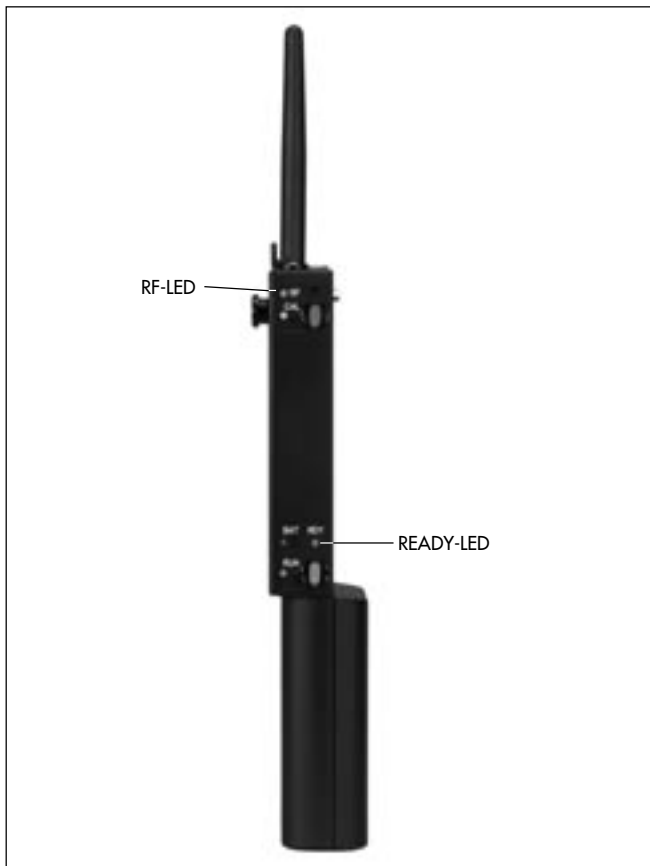

5.1.2.2 Quality of the radio connection

The LED RF ⇔ **photo** shows whether the quality of the radio transmission is sufficient. As long as the LED RF is green, the radio connection is perfect. If the LED is illuminated briefly red, this means that a data packet has been lost. The packet will automatically be re-transmitted and the lens adjustment is still correct.

If the LED lights up red several times briefly, or continuously, it must be assumed that lens adjustment is no longer being performed correctly. If the LED flashes red, the radio connection has been interrupted for longer than a second. If there is no radio connection for over 40 seconds, the WMU-1 switches off.

The radio connection is best when there is visual contact between the antennas of the URM-1 and the WMU-1 and when the distance between URM-1 and WMU-1 is as small as possible. The maximum range inside depends on the particular building and is typically approx. 30m. Outdoors the range is approx. 100m.

5.1.2.3 Switching on

- Before switching on, ensure that
 - the desired radio manual control units (WFU-1, WZU-1) are attached and correctly configured,
 - the same radio channel is programmed on the WMU-1 and the URM-1,
 - the support rods are securely fastened to the camera
 - the motor units are securely fastened to the support rods
 - the motor drive gear engages the lens gear ring with as little play as possible.

- Switch the main switch on the universal motor controller UMC-1 ⇨ **photo** to ON.

Note: The UMC-1 must always be switched on prior to the WMU-1.

- Switch on the power supply with the ON key ⇨ **photo** on the WMU-1.
During calibration no WMU-1 can be switched on.

Note: If the UMC-1 is switched off while radio contact exists, all connected WMU-1 units will also be automatically switched off.



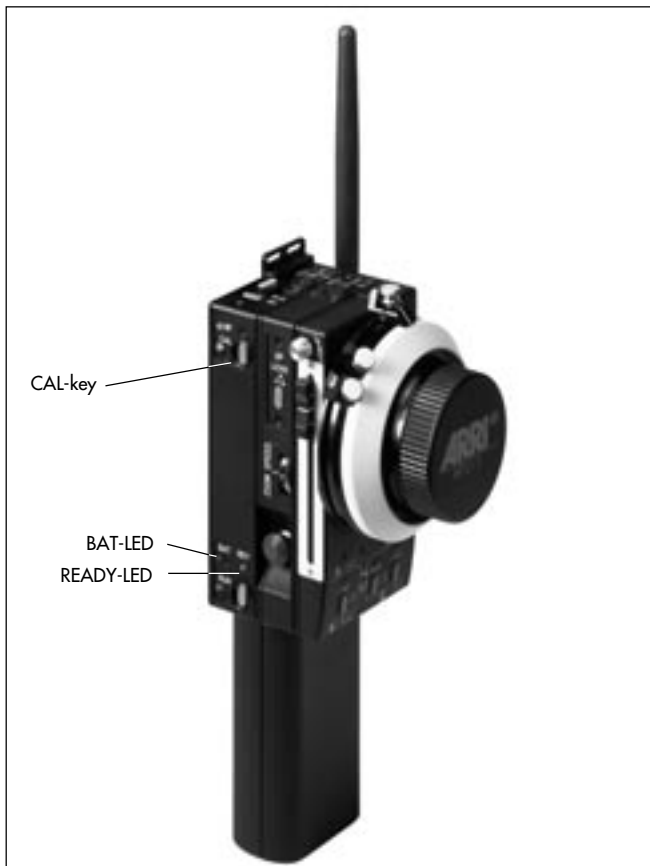

The READY LEDs on the WMU-1 ⇨ **photo** and the motor unit CLM-1 or the universal motor controller UMC-1 will briefly illuminate red. Then the Ready LED on the WMU-1 will show the status of the LCS:

green	LCS is ready for operation
red	operating error on one unit (e.g. incorrect key pressed, WMU-1 switched on before UMC-1)
flashing red	the selector switch on the motor unit is incorrectly set or connected to the incorrect socket on the UMC-1

Note: The LEDs on the CLM-1 or UMC-1 flash green when the lens reaches the end of the set operating range.

- Calibrate the motor end stops by pressing the CAL-key ⇨ **photo** on the WMU-1. During calibration no extra WMU-1 can be switched on.

Note: All WMU-1 or ZMU-1 units must calibrate all lens rings connected to the respective unit.

- Select the desired direction with the drive direction switch on the CLM-1 motor unit ⇨ **photo** or on the switches beside the sockets of the UMC-1 ⇨ **photo**.

5.1.2.4 Resuming operation after an extended break

If a lens ring was moved manually while the LCS was switched off, the stored values for the lens end stops will no longer be correct. So:

- switch on the LCS and recalibrate.

5.1.2.5 Battery Control (BAT)

When the battery control LED (BAT) ⇨ **photo** on the WMU-1 flashes, the battery must be replaced. The operating time of a battery is approx. 5 hours.



Do not begin any new scenes!

Meaning of the BAT LED signals:

illuminated red	WMU-1 will work for approx. 15 min
flashing red	WMU-1 will work for approx. 5 min
fast flashing red	WMU-1 will switch off in approx. 5 s.

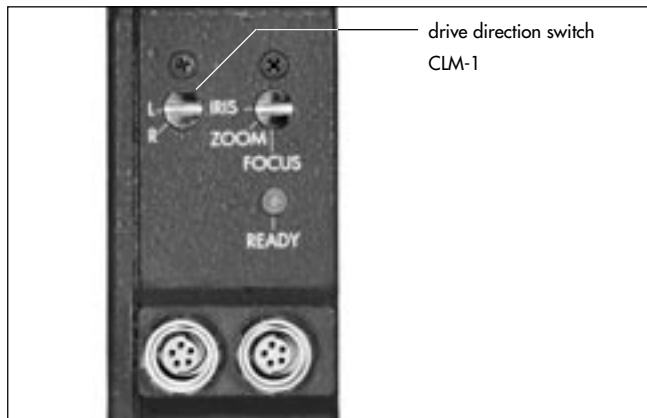

drive direction switch
CLM-1



drive direction switch (Zoom) UMC-1

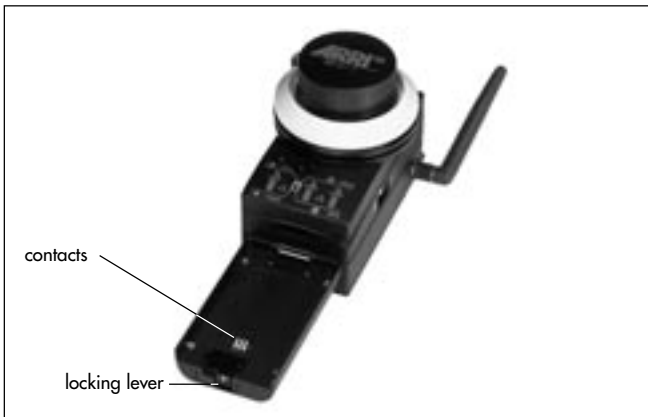
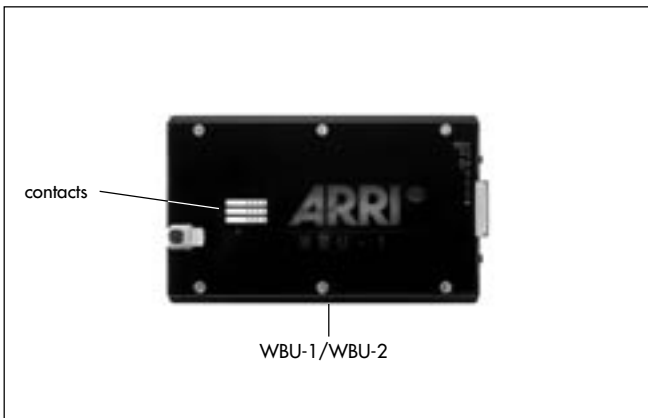

5.1.2.6 Replacing the battery WBU-1/WBU-2 (Wireless Battery Unit)



Never place the battery contacts on a conductive surface. Do not short-circuit the battery.



To protect the battery contacts on the WMU-1, a battery should always be attached to the WMU-1.

Note: The batteries consist of 6 nickel metal hydride cells. The rated capacity for the WBU-1 is 1.6 Ah, for the WBU-2 is 2 Ah. The charge time is approx. 1.5 h.

- Switch off the WMU-1 by pressing the ON key.
- Push away the locking lever ⇨ **photo** from the battery and pull the battery backwards to remove it.
- Insert a fully charged battery with its wide black pin facing the surface and push into the holder until the battery clicks in audibly.

5.1.2.7 Charging the batteries WBU-1/WBU-2



Only charge batteries in dry rooms!



Only original ARRI WBU-1/WBU-2 batteries may be charged. Do not charge any non-rechargeable batteries!



The ARRI WBU-1/WBU-2 batteries must not be thrown into normal household waste; they must be disposed of according to the regulations!



Only operate the WAC-1 (Wireless Accumulator Charger) with its accompanying power supply, otherwise the battery may be severely damaged!



Do not short-circuit the contacts of the WAC-1!

- Push the adapter plug ⇨ **photo** suited to your country onto the power supply. Alignment to the voltage is automatic.

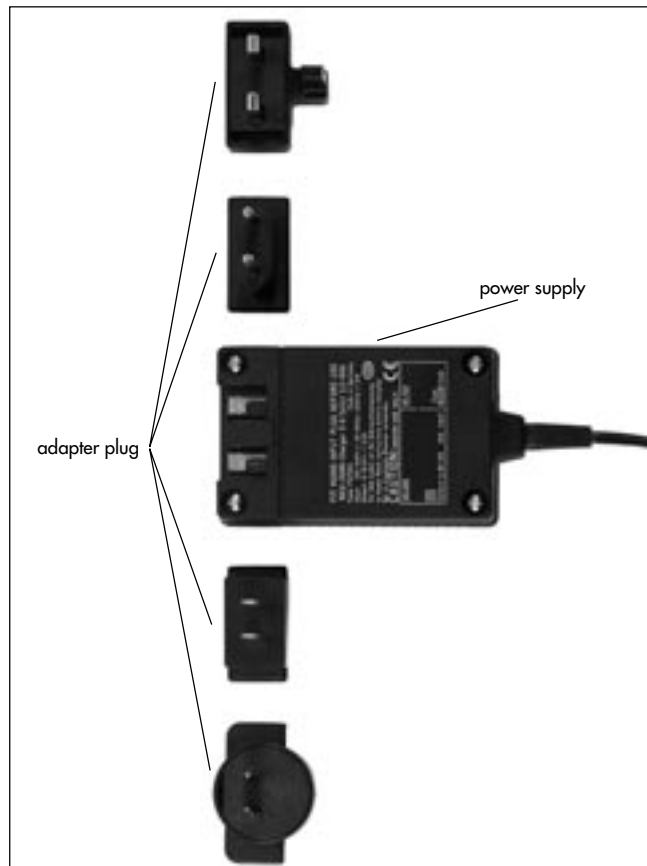

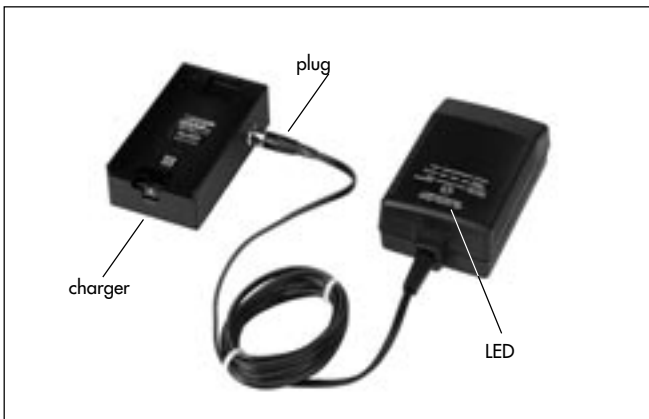

- Connect the round plug ⇨ **photo** on the power supply to the Charger ⇨ **photo**.
- Insert the WBU-1/WBU-2 to be charged with its wide black pin facing the surface and push into the holder until the battery clicks in audibly.
- Connect the power supply to the mains. The LED on the power supply ⇨ **photo** is illuminated red.
- The WBU-1/WBU-2 is fully charged when the power supply LED flashes ⇨ **photo** red.
- Push away the locking lever ⇨ **photo** from the battery and pull the fully charged battery backwards to remove it.

5.1.2.8 Calibration

The end stops of the lens rings are defined and stored during the automatic calibration process in order to prevent driving the lens ring up against the lens' end stops. Previously set values are thereby erased.

Calibration must be carried out

- during initial set-up,
 - after a lens change,
 - after the lens control ring has been manually moved while the units were disconnected from the power, e.g. after an extended break
 - after the motor drive gear has been removed from the lens control ring.
- To calibrate press the CAL key → **photo** on the WMU-1. While the LCS is calibrating, the CAL-LED on the WMU-1 is illuminated yellow, the motor LEDs on the UMC-1 are flashing red/green. Only those axes are calibrated for which a manual control unit is available. During calibration no extra WMU-1 can be switched on.



The CAL-LED flashes:

Lens end stops are not yet defined, or the lens has been moved while the LCS was switched off and then driven against the end stops. Recalibrate!

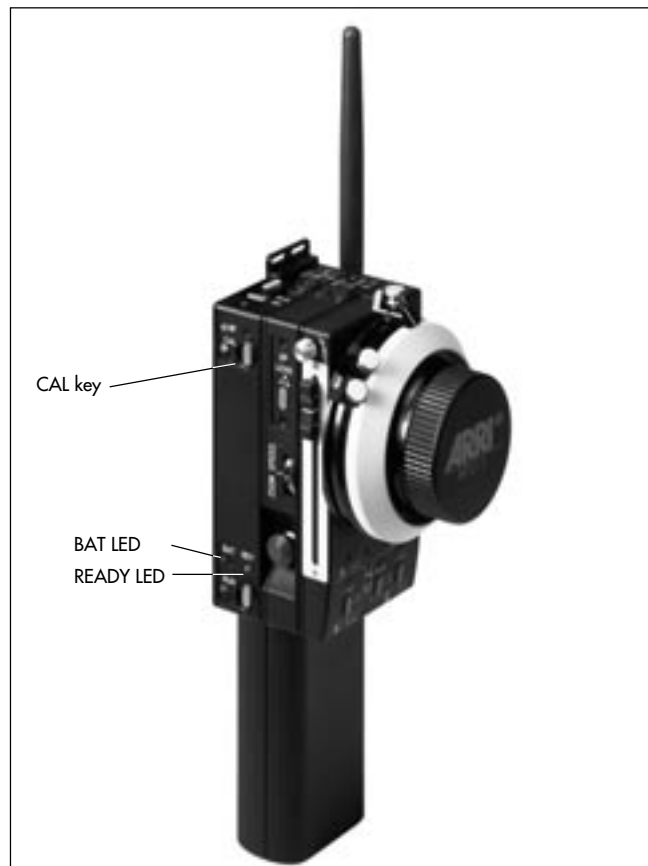

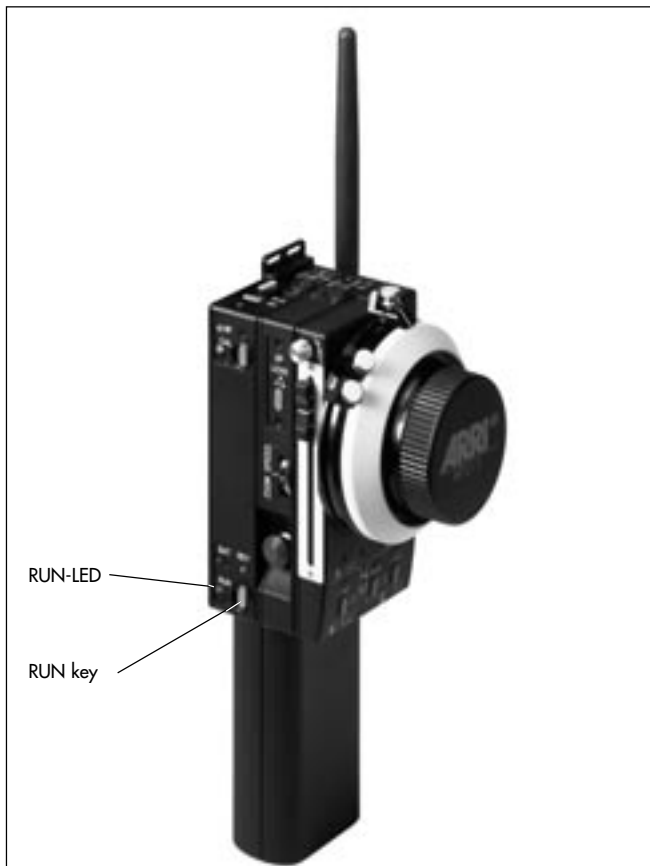

5.1.2.9 Camera RUN

- To start or stop the camera:
Press the RUN key ⇨ **photo**.

The RUN-LED ⇨ **photo** is illuminated green while the camera is running.

In REMOTE-RUN operation with the ARRIFLEX 35 BL, 35 III and 16 SR II the camera can only be stopped with the key with which it was started.

Note: While the camera is running, the UMC-1 and the WMU-1 cannot be switched off.

5.1.3 Operating the WZU-1 (Wireless Zoom Unit)

5.1.3.1 Mounting the WZU-1 on the WMU-1

- Switch off the WMU-1 with the ON key.
- To detach a WFU-1 (Wireless Focus Unit) if attached, press the release key ⇨ **photo**, swing away the WFU-1 and pull up to remove it.
- Insert the WZU-1 with its wide black pin ⇨ **photo** facing into the free space on the WMU-1, then press the WZU-1 onto the WMU-1 until the module clicks in audibly.

Note: Do not separate the manual control units from each other while switched on, as this could lead to functional errors, e. g. unintentional alteration of lens end stops.

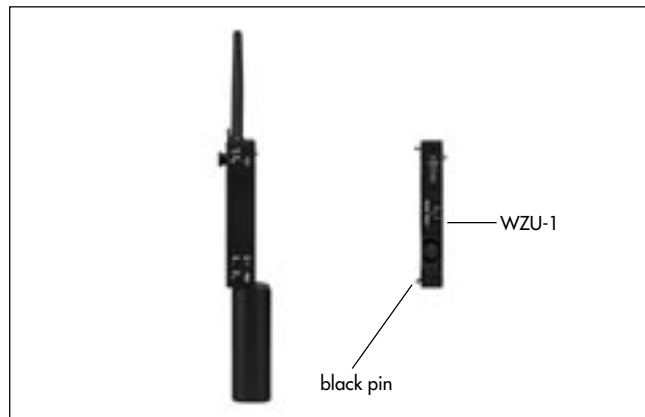
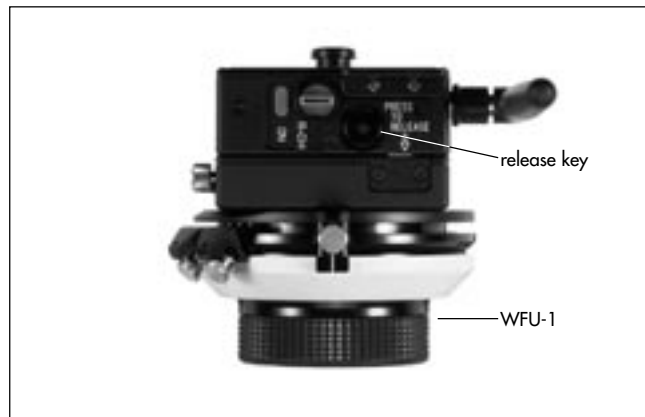

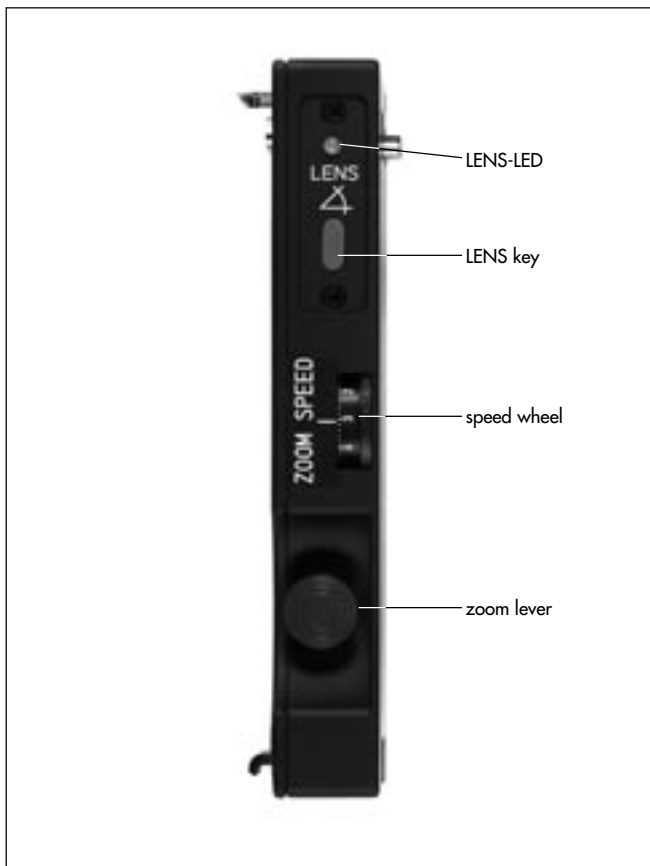

5.1.3.2 Zooming

- Prior to operation, the end stops of the lens must be calibrated (see chapter 5.1.2.8 Calibration).
- Press the zoom lever ⇨ **photo** in the desired direction.

The focal length will be altered. The greater the force, the faster the zoom will react.

5.1.3.3 Defining the zoom range

For zooming a defined range can be selected and stored.

- Drive the zoom ring to one end of the selected range.
- Press the LENS key ⇨ **photo**, and hold down. The LENS LED will flash.
- Drive the zoom ring to the other end of your selected range, and release the LENS key. The LENS LED will now be illuminated.

When redefining the zoom range, the range can only be smaller. If this is not desired, the zoom range must first be erased and then redefined.

5.1.3.4 Erasing the zoom range

- Press the LENS key ⇨ **photo** and hold down briefly. The LENS-LED ⇨ **photo** switches off.

5.1.3.5 Setting zoom speed

The sensitivity of the zoom lever is pre-selected with the speed wheel ⇨ **photo**. At maximum zoom speed (10), a mains supply of 24V and full deflection of the zoom lever, a half turn (180°) takes 1 second. At the slowest speed (1) it takes about 2 minutes (for lenses with 130 mm diameter gear ring). Even slower speeds can be achieved with smaller deflections of the zoom lever.

5.1.3.6 ZAP-Function

- The ZAP key ⇨ **photo** switches to maximum zoom speed – independently of the speed wheel setting.

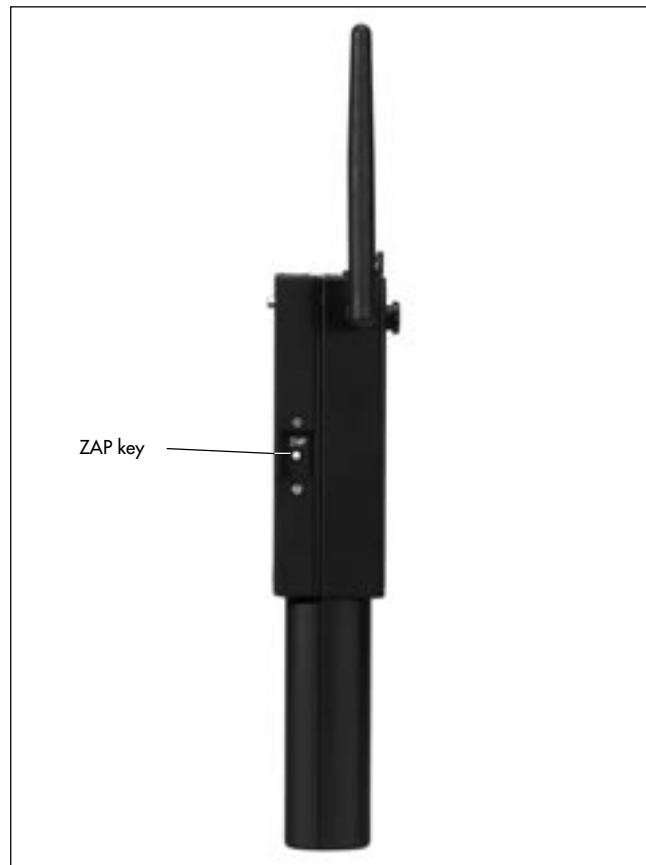

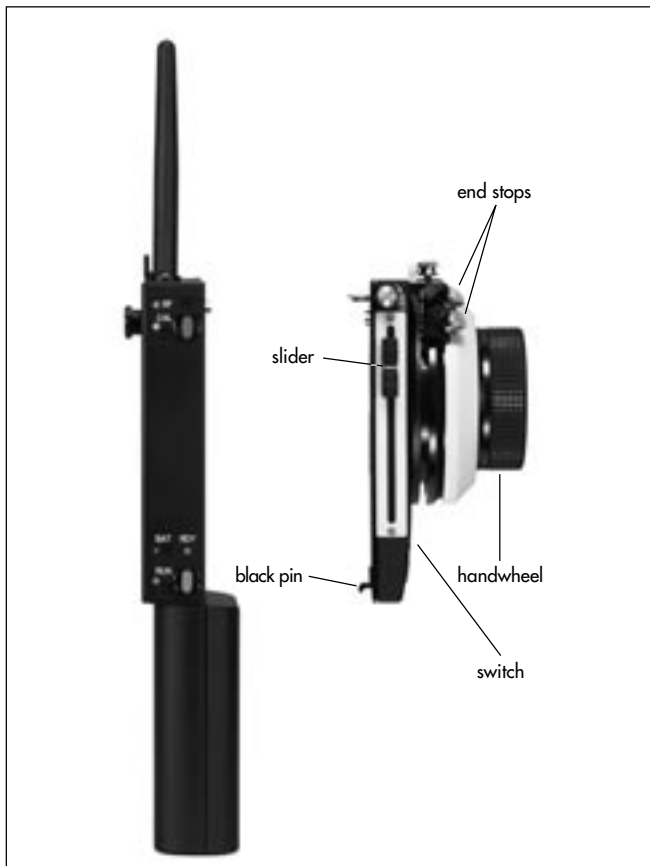

5.1.4 Operating the WFU-1 (Wireless Focus Unit)

With a WFU-1, the focus and iris rings can be controlled remotely. It is however also possible to control focus with one WFU-1 and iris with a second WFU-1. In this case each WFU-1 must be operated with its own WMU-1.

The WFU-1 has two main operating elements: a handwheel ⇔ **photo** with stops ⇔ **photo** and a slider ⇔ **photo**. With the switch on the front side of the WFU-1 it is possible to determine whether focus or iris is to be controlled with the handwheel. The slider then controls the remaining lens ring.

If two WFU-1 units are used for focus and iris, for each WFU-1 a separate WMU-1 is necessary. Before switching on both WMU-1 units, the WFU-1 switches must be set to different positions. In this case only the two handwheels are used for control; the sliders are deactivated.

As operating the handwheel and the slider is independent from the particular lens ring (focus or iris), only operation of the handwheel and the slider is described in the following two chapters.

5.1.4.1 Attaching the WFU-1 to the WMU-1

- Switch off the WMU-1 with the ON key.
- Insert the WFU-1 with its wide black pin facing it → **photo** into the free space on the WMU-1 or on the WZU-1, then push the WFU-1 onto the WMU-1 or the WZU-1 until the module clicks in audibly.

Note: Do not separate the manual control units from each other while switched on as this could lead to functional errors, e. g. unintentional alteration of lens end stops.



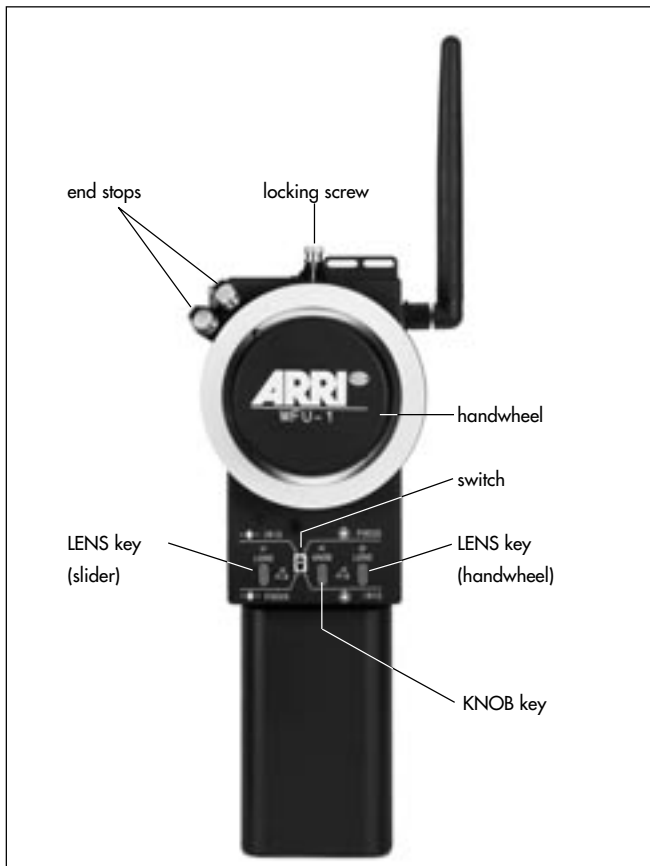

5.1.4.2 Determining whether the handwheel should control focus or iris

- Turn the switch ⇔ **photo** in the middle of the operating field of the WFU-1 to the desired position. To operate focus with the handwheel, push the switch in the direction of the handwheel.

5.1.4.3 Operating the handwheel on the WFU-1

- Prior to operation, the end stops of the used lens must be calibrated (see chapter 5.1.2.8 Calibration).

Focus or Iris Adjustment

- Adjust the handwheel ⇔ **photo** of the WFU-1.

The lens ring follows the handwheel adjustment very precisely and smoothly.

When quickly turning the handwheel, focus and iris adjustment follows with the maximum speed of the lens control motors (at 12V the maximum adjustment speed is lower).

Fixing the Handwheel in Position

To prevent unintentional moving of the handwheel, it can be fixed in its position.

- To fix in position, turn the locking screw ⇨ **photo** clockwise.
- To loosen, turn the locking screw anti-clockwise.

Defining the Adjustment Range of the Lens

For each ring on the lens controlled by the LCS, a setting range can be defined and stored. The smaller this range, the more precisely setting can be carried out.

With the corresponding control unit, set the range as follows:

- Drive to the beginning of the selected range by adjusting the handwheel.
- Press the LENS key and hold down
– LENS-LED ⇨ **photo** flashes.
- Drive to the end of the selected range by adjusting the handwheel.
- Release the LENS key
– LENS-LED illuminates.



The selected operating range must cover at least 2% of the entire lens range. Otherwise the setting will have no effect.

Erasing the Setting Range

- Press the LENS key ⇨ **photo** and hold down briefly
– LENS-LED switches off.

Matching the Scale Range to the WFU-1

On the focus scale disk of the WFU-1 a scale range can be selected by marking as desired. Previously marked focus disks can be used, e.g. from mechanical follow-focus devices.

For each WFU-1 the scale range is aligned to the stored setting range of the lens ring as follows:

- With the mechanical end stops ⇨ **photo** of the handwheel, set the limits of the desired scale range and fix them.
- Turn the handwheel to the first end stop.
- Press the KNOB key ⇨ **photo** and hold down
– KNOB-LED flashes.

- Turn the handwheel to the second end stop and release the KNOB key
 - KNOB LED illuminates.



The set scale range must be at least 30° on the handwheel. Otherwise the setting will have no effect.

Erasing the Scale Range

- Press the KNOB key and hold down briefly
 - KNOB-LED switches off.

Using Scales from Mechanical Follow-Focus Devices

If a focus disk is firstly to be marked on a mechanical follow-focus device and then used on the WFU-1, it must be set up on the follow-focus device as follows:

- Turn the handwheel on the follow-focus device clockwise to the lens end stop.
- Move the index indicator of the follow-focus device to the disk-positioner pin.
- Fix the index indicator in this position.
- Mark the scale.

Scales marked in this way can be used for LCS focus-iris operation. Match the scale ranges as described above.

5.1.4.4 Operating the slider on the WFU-1

- Prior to operation, the end stops of the used lens must be calibrated (see chapter 5.1.2.8 Calibration).

Focus or Iris Setting

- Shift the slider ⇨ **photo** of the WFU-1.

The lens ring follows the sliding switch adjustment very precisely and smoothly.

When moving the slider very quickly, focus and iris adjustment follow at maximum speed (at 12V the maximum speed is lower).

Fixing the Slider in Position

To prevent unintentional moving of the slider, it can be fixed in position.

- Turn the locking screw ⇨ **photo** clockwise to fix in position.
- Turn the locking screw anti-clockwise to release.

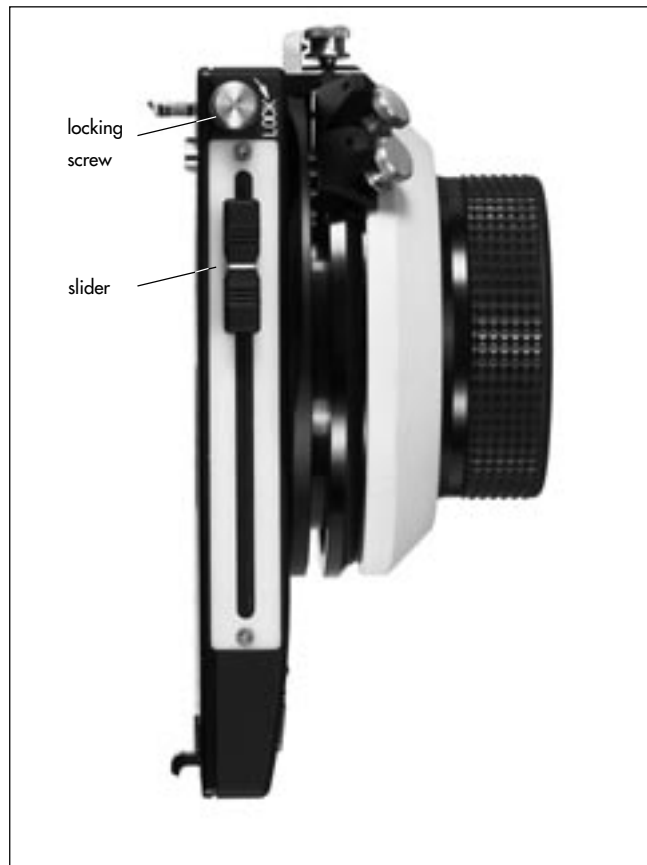

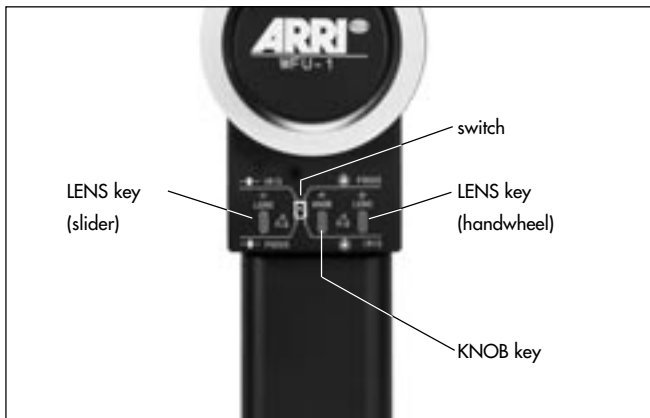

Defining The Lens Setting Range

For each ring of the lens controlled by the LCS, a setting range can be defined and stored. The smaller the setting range, the more precisely setting can be carried out.

With the corresponding control unit the range can be set as follows:

- Drive to the beginning of the selected range by adjusting the slider (handwheel).
- Press the LENS key and hold down – LENS-LED ⇨ **photo** flashes.

- Drive to the end of the selected range by adjusting the sliding switch.
- Release the LENS key – LENS-LED illuminates.



The selected operating range must cover at least 2% of the entire lens range. Otherwise the setting will have no effect.

Erasing the Setting Range

- Press the LENS key and hold down briefly – LENS-LED switches off.

5.1.5 Operating several units

If a lens is to be remotely operated by several units (several WMU-1), the following applies:

If two WFU-1 units are active and if their selector switches are set to different positions, on both units only the rotary knob is active for the selected lens ring. Both sliders on the units are deactivated, and the sequence in which they are switched on has no effect.

As a maximum, three WMU-1 can be operated.

5.1.6 Radio Unit accessories

In order to further reduce the weight to be held in the hand, it is possible to fasten the WMU-1 to your belt. An extension WEU-1 (Wireless Extension Unit) between the WMU-1 and the manual control units WFU-1 and WZU-1 is available.

The extension WEU-1 ⇨ **photo** (Ident-No. K2.52056.0) consists of:

The attachment piece for the manual controls WHA-1 ⇨ **photo** (Wireless Handgrip Attachment) (Ident-No. K2.52070.0).

The attachment piece for the main unit WMA-1 ⇨ **photo** (Wireless Main Attachment) (Ident-No. K2.52071.0).

The extension cable WC-E1 (1m) ⇨ **photo** (Ident-No. K4.52336.0).

A longer cable WC-E2 (3m) is also available (Ident-No: K2.52084.0).

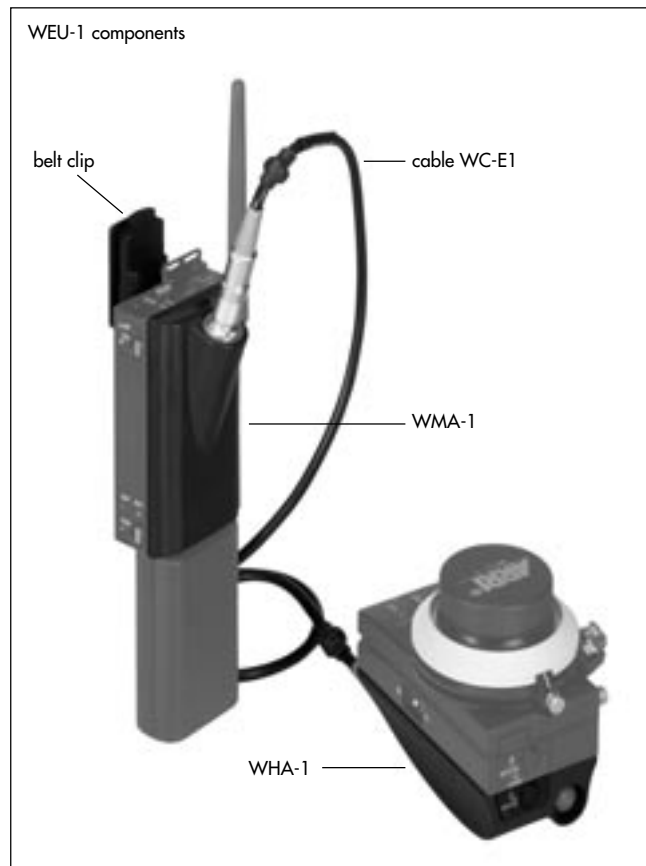



Attaching the Extension WEU-1

- Switch off the WMU-1 with the ON key.
- To detach a WFU-1, press the release key ⇨ **photo**, swing away the WFU-1 and then pull upwards to remove it.
- Insert the WMA-1 for the WMU-1 with the wide black pin facing into the free space on the WMU-1 (or WZU-1), then press the WMA-1 onto the WMU-1 (or WZU-1) until the module clicks in audibly.
- Insert the WZU-1 or the WFU-1 with its wide black pin facing into the free space of the Wireless Handgrip Attachment WHA-1, then press the WZU-1 or WFU-1 onto the WHA-1 until the module clicks in audibly.
- Connect the two attachment pieces WHA-1 and WMA-1 to each other with a cable WC-E1 ⇨ **photo** or WC-E2.

- Clip the belt clip ⇨ **photo** onto your trousers belt and clip the pin on the WMU-1 into the belt clip.



Check that the WMU-1 is fastened securely to your belt!

- To release the WMU-1, press the release lever ⇨ **photo** on the belt clip and pull the WMU-1 with its attachment pin out of the holder.

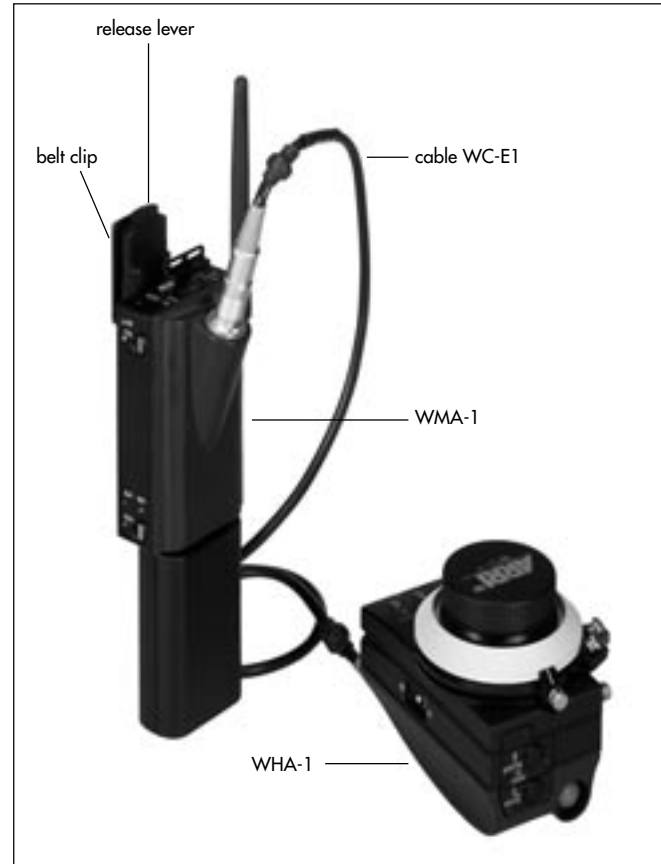

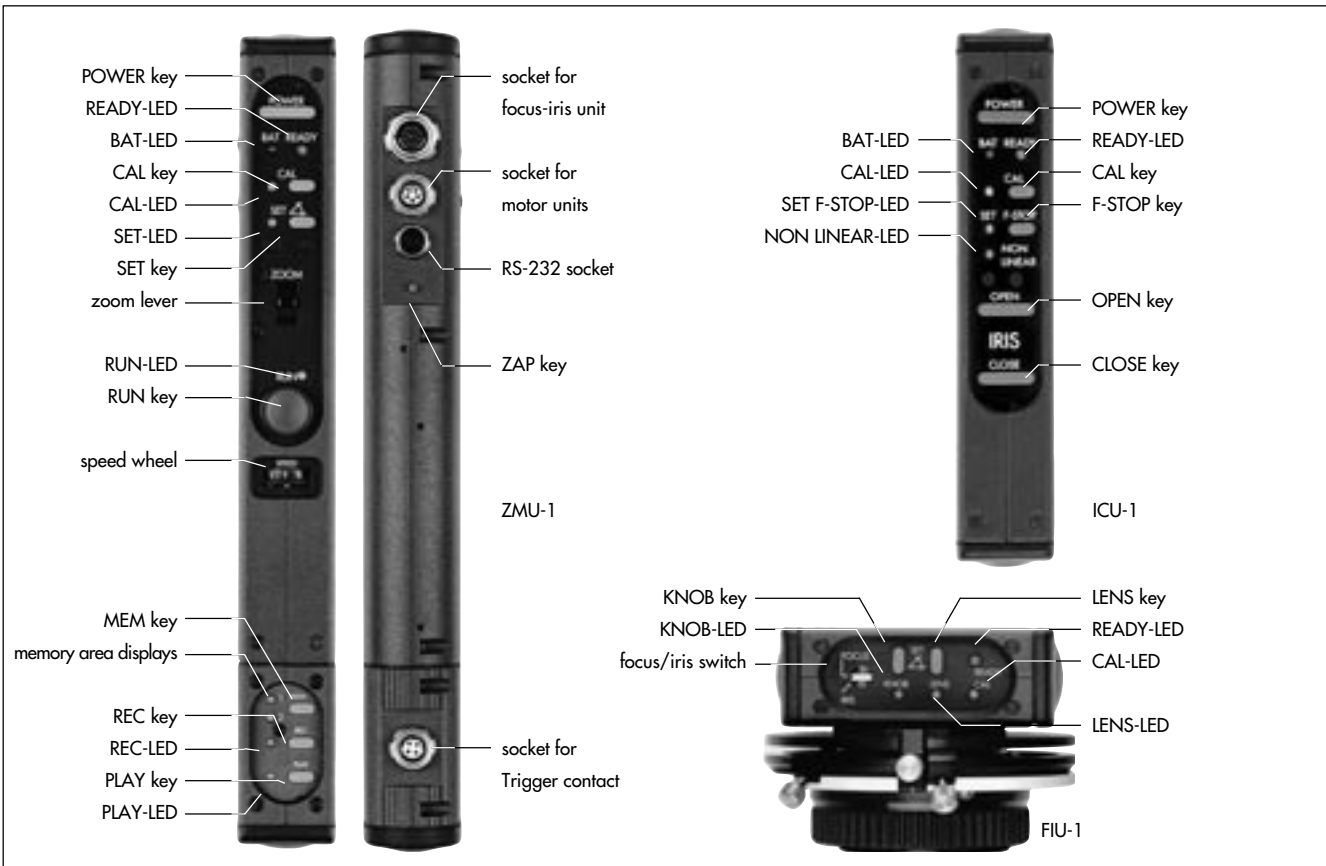

5.2 Remote Control via Cable

5.2.1 Manual control units for remote control via cable

For remote control of the lens via cable a ZMU-1 (Zoom Main Unit) is always necessary as a main unit.

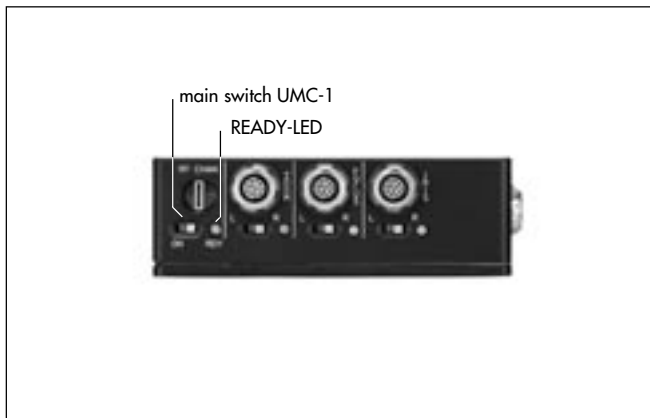

5.2.2 Operating the ZMU-1 (Zoom Main Unit)

5.2.2.1 Switching on

- Before switching on, ensure that
 - the support rods are securely fastened to the camera,
 - the motors unit is securely fastened to the support rods,
 - the motor drive gear engages the lens gear ring with as little play as possible.
- If a Universal Motor Controller UMC-1 is to be used, switch its main switch ⇨ **photo** to ON.
- Switch on the power supply with the POWER key ⇨ **photo** on the Zoom Main Unit ZMU-1.

Note: If the Universal Motor Controller UMC-1 is switched off and on again, the ZMU-1 must also be reset by switching off and on.

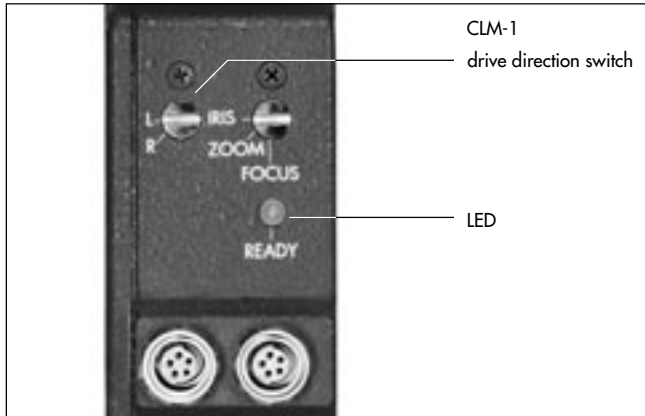
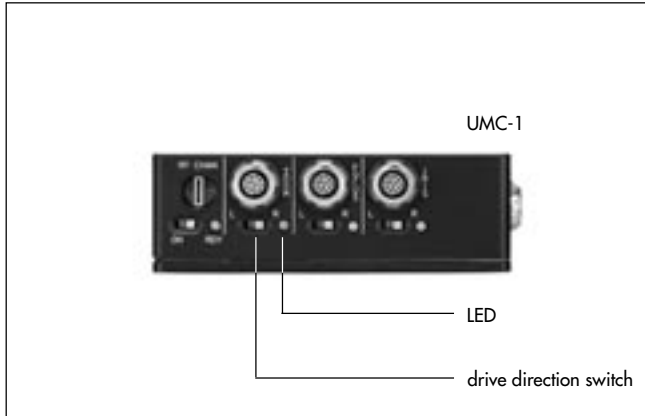

The READY-LEDs on the ZMU-1 ⇨ **photo** and the motor unit CLM-1 or the UMC-1 briefly illuminate red, then the READY-LED on the ZMU-1 displays the status of the LCS:

green	LCS is ready for operation
red	operating error on one unit (e.g. incorrect key pressed, ZMU-1 switched on before UMC-1) or power cable LC-S1 defective (see also chapter 7. Trouble-Shooting)
flashing red	selector switch on the motor unit is incorrectly set or connected to the incorrect socket of the UMC-1 motor unit is not connected cable defective (see also chapter 7. Trouble-Shooting)

Note: The LEDs on the CLM-1 ⇨ **photo** or the UMC-1 ⇨ **photo** flash green if the lens is at the end of the set operating range.

- Then press the CAL key ⇨ **photo** on the ZMU-1 to calibrate the motor end stops.
- Select the desired drive direction of the zoom adjustment with the drive direction switch on the CLM-1 motor ⇨ **photo** unit or on the zoom socket on the UMC-1 ⇨ **photo**.

5.2.2.2 Resuming operation after a break with power down

If a lens ring was moved manually while the LCS was switched off, the stored values for the lens end stops will no longer be correct. So:

- Switch on the LCS and recalibrate.

5.2.2.3 Battery Control (BAT)

When the battery control LED (BAT) ⇨ **photo** on the zoom unit flashes, replace the battery.

Do not start any new scenes!

- If the battery control LED flashes, replace the battery immediately (danger of completely discharging the battery).

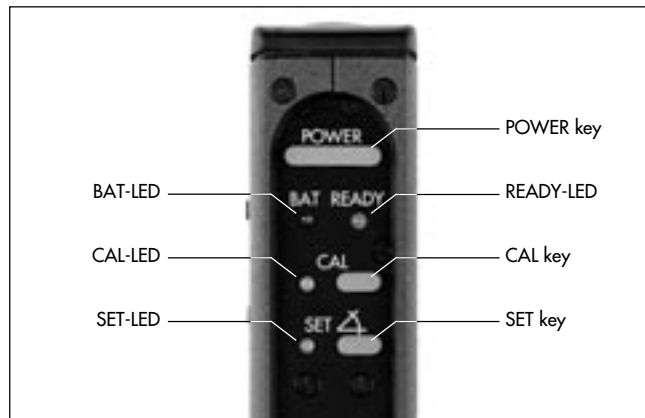

The battery control reacts to the following voltage limits:

Battery	BAT-LED	Voltage
24V	illuminated	<20V
	flashing	<18V
12V	illuminated	<10V
	flashing	<9V

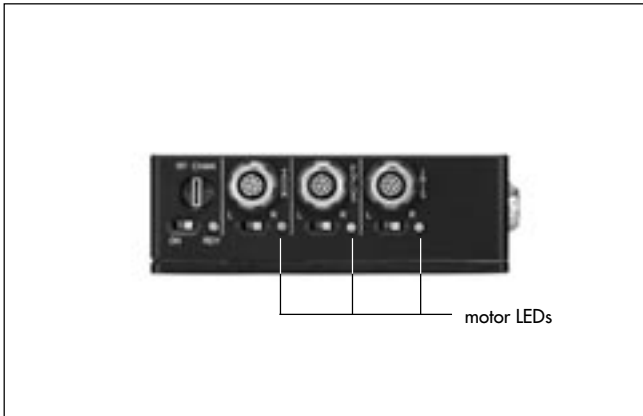
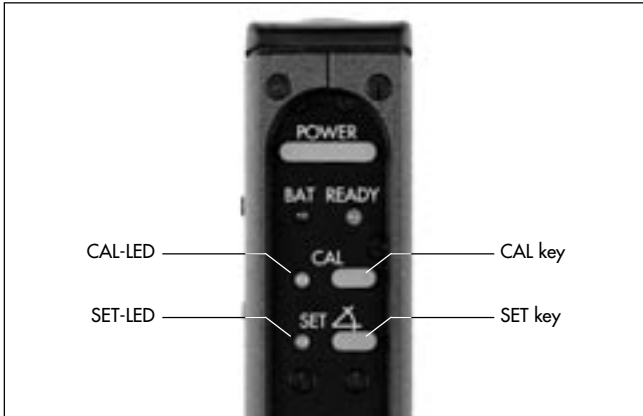

5.2.2.4 Calibration

The end stops of the lens rings are defined and stored during the automatic calibration process to prevent driving the lens ring up against the lens' end stops. Previously set values are thereby erased.

Calibration must be carried out

- during initial set-up
- after a lens change
- after the lens control ring has been manually moved while the units were disconnected from the power, e.g. after an extended break
- after the motor drive gear has been removed from the lens control ring.

- To calibrate on the ZMU-1, press the CAL key ⇨ **photo**.

While the LCS is calibrating, the CAL-LED ⇨ **photo** on the ZMU-1 is illuminated yellow, the motor LEDs on the UMC-1 ⇨ **photo** flash red/green.



The CAL-LED flashes:

Lens end stops not yet defined, or the lens has been moved while the LCS was switched off and then driven against the end stops. Recalibrate!

5.2.2.5 Zooming

- Turn the zoom lever ⇨ **photo** in the desired direction. The focal distance will be altered. The greater the deflection, the faster the zoom will react.

5.2.2.6 Defining the zoom range

For focal length adjustment, a defined range can be selected and stored.

- Drive the zoom control ring to the beginning of the selected range.
- Press the SET key ⇨ **photo**, and hold down. The SET-LED ⇨ **photo** will flash quickly.
- Drive the zoom control ring to the end of the selected range, and release the SET button. The SET-LED will now be illuminated.

When redefining the zoom range, the range can only be smaller. If this is not desired, the zoom range must first be erased and then redefined.



5.2.2.7 Erasing the zoom range

- Press the SET key ⇨ **photo** and hold down briefly. The SET-LED ⇨ **photo** switches off.

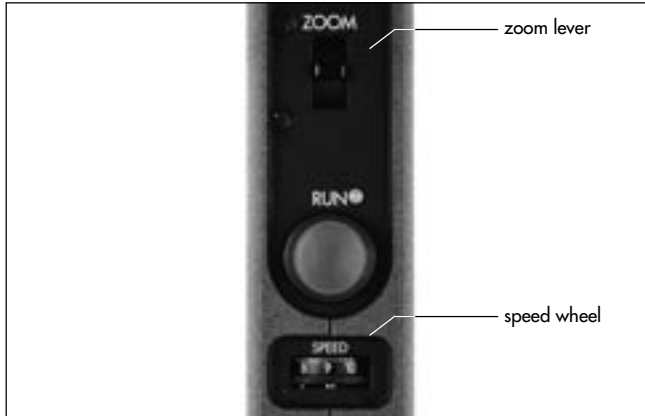

5.2.2.8 Setting zoom speed

The sensitivity of the zoom lever is pre-selected with the speed wheel ⇨ **photo**. At maximum zoom speed (10), a mains supply of 24V and full deflection of the zoom lever, a half turn (180°) takes 1 second. At the slowest speed (1) it takes about 2 minutes (for lenses with 130 mm diameter gear ring). Even slower speeds can be achieved with smaller deflections of the zoom lever.



5.2.2.9 ZAP-Function

The ZAP-key ⇨ **photo** switches to maximum zoom speed – independently of the speed wheel setting.

5.2.2.10 Camera RUN

- To start or stop the camera:
Press the RUN key ⇨ **photo**.

The RUN-LED ⇨ **photo** is illuminated green while the film is running.

During REMOTE-RUN operation with the ARRIFLEX 35 BL, 35 III and 16 SR II, the camera can only be stopped with the key with which it was started.

Note: While the camera is running, the UMC-1 and the ZMU-1 cannot be switched off.

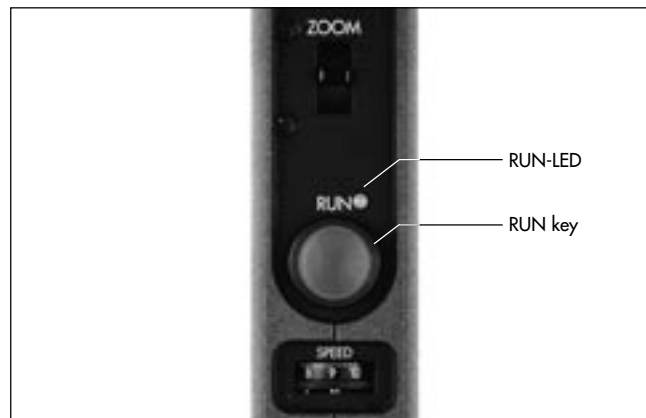

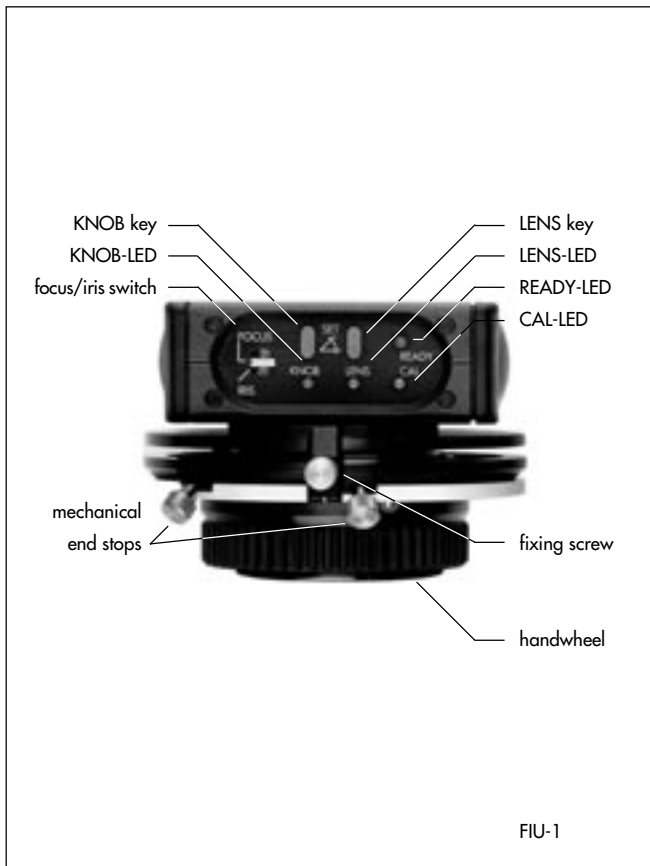

5.2.3 Operating the FIU-1 (Focus Iris Unit)

With an FIU-1 ⇔ **photo** either a focus ring or an iris ring can be remotely controlled. For use of the FIU-1 a ZMU-1 is always necessary as a main unit. The first FIU-1 is connected to the ZMU-1 with a cable LC-F1 or LC-F2. If a second FIU-1 is used, this can be connected to the first FIU-1 with a cable LC-F1 or LC-F2.

5.2.3.1 Defining the function of the FIU-1

Switch on the FIU-1 with the ZMU-1. Before switching on, it is necessary to determine whether the FIU-1 is to control a focus ring or an iris ring.

- Using a coin, turn the switch Focus/Iris ⇔ **photo** to the desired position.

Note: If only one FIU-1 is used, the function (Focus/Iris) can also be altered while switched on.

5.2.3.2 Focus or iris setting

- Turn the handwheel ⇨ **photo** of the FIU-1.

The focus ring of the lens follows the handwheel adjustment very precisely and smoothly.

When quickly turning the handwheel, focus and iris adjustment follow the lens control motors at maximum speed (at 12V the maximum adjustment speed is lower).

5.2.3.3 Fixing the handwheel in position

To prevent unintentional moving of the handwheel, it can be fixed in its position.

- To fix in position, turn the locking screw ⇨ **photo** clockwise.
- To loosen, turn the locking screw anti-clockwise.

5.2.3.4 Defining the setting range of the lens

For each setting ring on the lens controlled by the LCS, a setting range can be defined and stored. The smaller this range, the more precisely setting can be carried out.

The setting range is determined individually for each axis. On the Focus Iris Unit the LENS key ⇨ **photo** is used:

With the corresponding control unit, set the range as follows:

- Drive to the beginning of the selected range by adjusting the handwheel.
- Press the LENS key ⇨ **photo** and hold down
– LENS-LED ⇨ **photo** flashes.
- Drive to the end of the selected range by adjusting the handwheel.
- Release the LENS key
– LENS-LED illuminates.



The selected operating range must cover at least 2% of the entire lens range. Otherwise the setting will have no effect.

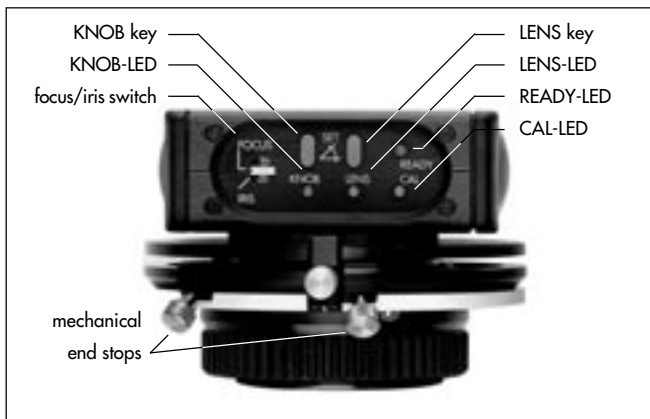

5.2.3.5 Erasing the setting range

- Press the LENS key ⇨ **photo** and hold down briefly
 - The LENS-LED ⇨ **photo** switches off.

5.2.3.6 Matching the scale range on the Focus Iris Unit

On the focus scale disk of the Focus Iris Unit a scale range can be selected with markings as desired. Already marked focus scale disks can be used, e.g. from mechanical follow-focus devices.

For each Focus Iris Unit the scale range is aligned to the stored setting range of the lens ring as follows:

- With the mechanical end stops ⇨ **photo** of the handwheel, set the limits of the desired scale range and fix them.
- Turn the handwheel to the first end stop.
- Press the KNOB key ⇨ **photo** and hold down
 - The KNOB-LED flashes.
- Turn the handwheel to the second end stop and release the KNOB key
 - The KNOB LED illuminates.



The set scale range must be at least 30° on the handwheel. Otherwise the setting will have no effect.

5.2.3.7 Erasing the scale range

- Press the KNOB key and hold down briefly
 - The KNOB-LED switches off.

5.2.3.8 Using scales from mechanical follow-focus devices

If a scale is firstly to be marked on a mechanical follow-focus device and then used on the Focus Iris Unit, it must be set up on the follow-focus device as follows:

- Turn the hanwheel on the follow-focus device clockwise to the lens stop.
- Move the index indicator of the follow-focus device to the disk-positioner pin.
- Fix the index indicator in this position.
- Mark the scale.

Scales marked in this way can be used for LCS focus-iris operation. Match the scale ranges as described above.

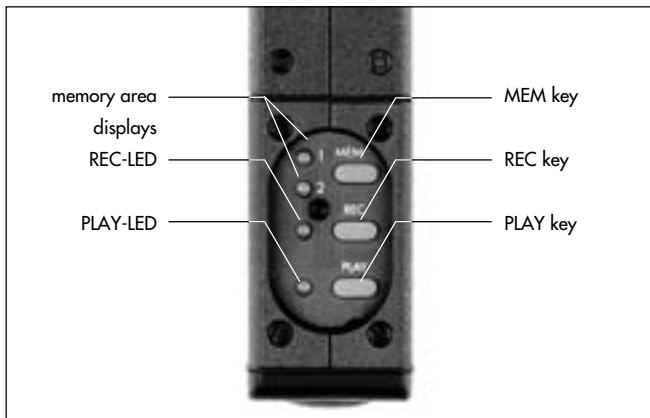
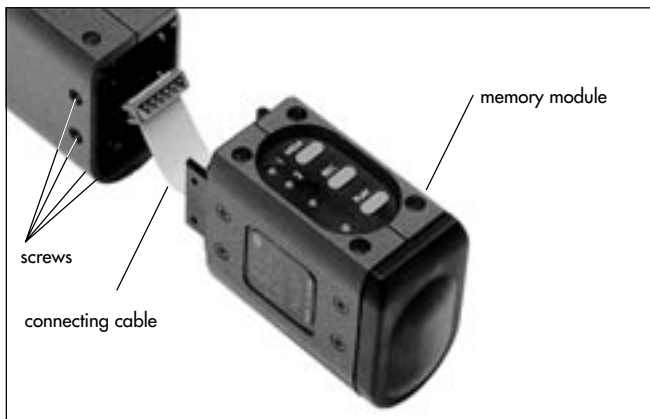

5.2.4 Memory Module

With the optional memory module functions of the zoom, iris or focus controls can be recorded and played back. Recording and playback can be started via an external trigger signal. The data is also stored even after switching the power supply off. As the memory module only functions together with the ZMU-1, the memory module functions are only available when using a cable.

Order Number: K2.41382.0

5.2.4.1 Installation

- Remove the screws that hold the cover on the bottom part of the zoom unit and remove the bottom cover.
- Plug the connecting cable into the zoom unit and the memory module ⇄ **photo**.
- Attach the memory module onto the zoom unit.
- Replace the cover on the memory module.
- Secure the unit with the appropriate screws.

5.2.4.2 Operating functions

The memory module's storage function has two memory banks. These can be used individually or simultaneously. According to the memory bank selection recording time is limited (see Technical Data).

Memory bank indicators 1 and 2 display how these memory banks can be used:

<input type="radio"/>	1	both memory banks are locked
<input type="radio"/>	2	no recording or playback possible
<input checked="" type="radio"/>	1	memory bank 1 active
<input type="radio"/>	2	recording and playback in memory bank 1 possible data in memory bank 2 remain stored
<input type="radio"/>	1	memory bank 2 active
<input checked="" type="radio"/>	2	recording and playback in memory bank 2 possible data in memory bank 1 remain stored
<input checked="" type="radio"/>	1	memory bank 1 and 2 active
<input checked="" type="radio"/>	2	recording and playback in memory bank 1 and bank 2 data in memory bank 1 and 2 will be erased

After switching on, the memory banks are locked to prevent accidental erasure of stored data.

Selecting Memory Bank

- Press the MEM key ⇨ **photo** repeatedly until the desired memory bank is active.

Recording Operating Functions

- Select the desired memory bank.
- To initialize:
Depress the REC key – the REC-LED ⇨ **photo** will flash. The LCS is ready for recording. This status can be cancelled by pressing the MEM key. If no memory bank has been pre-selected, memory bank LEDs 1 and 2 will flash. Select memory bank!
- To start recording:
Press the REC key again. During recording, the REC-LED will illuminate.
- To stop recording:
Press the REC key again or wait until the entire sequence has been recorded.

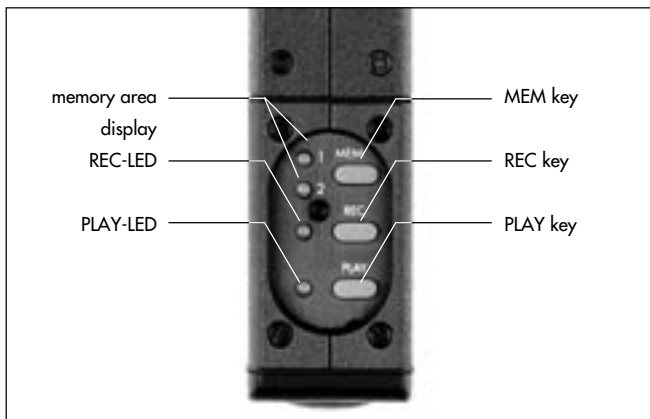

Playback Operating Functions

- Select the desired memory bank.
- To set the starting position:
press the PLAY key ⇨ **photo**.
During the search for the start positions, the PLAY-LED ⇨ **photo** will flash quickly; once the positions have been reached, the LED will flash slowly.

The unit is ready for playback. This status can be cancelled by pressing the MEM key.

If there is no recorded data in the memory bank, both memory bank LEDs will flash, and the READY-LED on the zoom unit will be illuminated red. Select the correct memory bank!

- To start playback:
press the PLAY key again.
During playback the PLAY-LED will be illuminated.
- To stop playback:
press the PLAY key again or wait until the entire sequence has been played back.

5.2.5 Trigger Function

The trigger function allows precisely timed activation of recording or playback functions of selected ranges. Operations like focusing on a moving object can be more accurately reproduced when the adjustments of the memory module are activated by the trigger functions via a remote activation signal.

5.2.5.1 Recording

- Select the desired memory bank.
- To initialize:
press the REC key ⇨ **photo**
– the REC-LED will flash. The LCS is ready for recording.

This status can be cancelled by pressing the MEM key.

If no memory bank has been pre-selected, memory bank LEDs 1 and 2 will flash. Select memory bank!

- To start recording:
connect the trigger contacts.
During recording, the REC-LED will be illuminated.

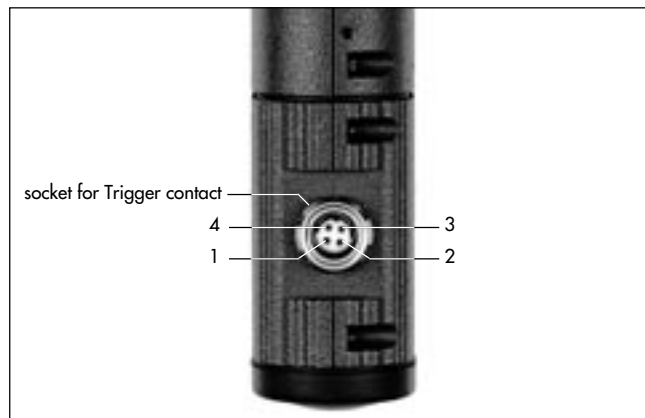

- To stop recording:
press the REC key again or wait until the entire sequence has been recorded.

1	TRIG +	Activate trigger mode by connecting both contacts
2	TRIG -	
3	-	not connected
4	-	not connected

5.2.5.2 Playback

- Select the desired memory bank.
- To set the starting positions: press the PLAY key. During the search for the start positions, the PLAY-LED will flash quickly; once the positions have been reached, the LED will flash slowly.

The LCS is ready for playback. This status can be cancelled by pressing the MEM key.

If there is no recorded data in the memory banks, both memory bank LEDs will flash, and the READY-LED on the zoom unit will be illuminated red. Select the correct memory bank!

- To start playback: connect the trigger contacts. During playback the PLAY-LED will be illuminated.
- To stop playback: press the PLAY key again or wait until the entire sequence has been played back.

5.2.6 ICU-1 (Iris Control Unit)

The ICU constantly monitors the frame rate of the camera. If a frame rate change occurs, the ICU will calculate a new value for the iris to compensate for the exposure change, and instruct the lens motor to change the iris ring accordingly.

Iris changes are calculated and set in such short time intervals that all changes are smooth - even if the camera's frame rate is changing very slowly.

Speed Ramp Overview

A speed ramp is a change of the camera's frame rate (fps), performed while the camera is running. Speed ramps can be used for a myriad of effects, from the dramatic speeding up or slowing down of the action to the subtle enhancing of a scene's timing. A speed ramp essentially allows the cameraman to compress or stretch time transparently and dynamically.

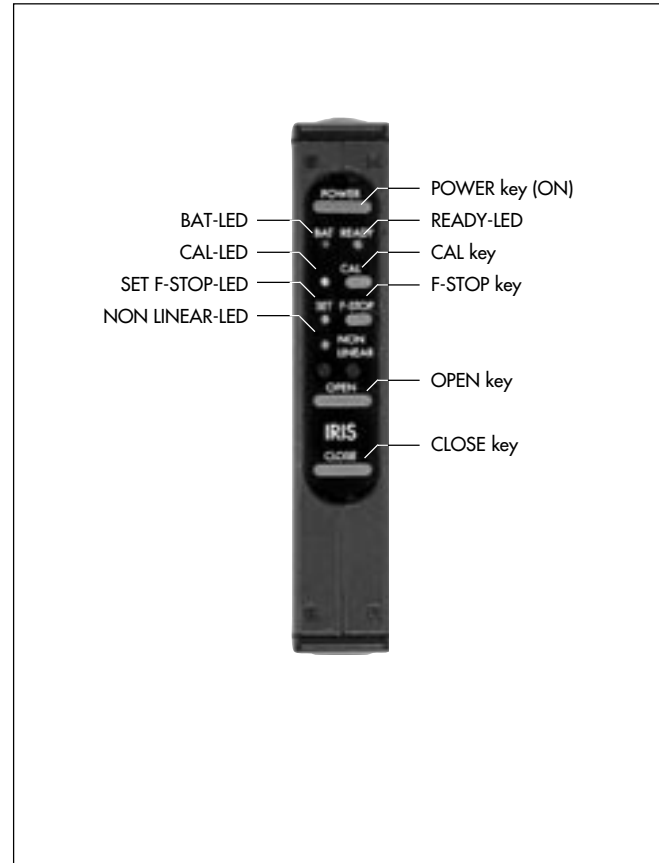

The frame rate of the new generation of ARRIFLEX cameras can be changed with the following accessories: RU-1 (Remote Unit), RCU-1 (Remote Control Unit), CCU-1 (Camera Control Unit) and LCC (Laptop Camera Controller).

Since each frame's exposure time is dependent on the camera's frame rate, the mirror shutter setting and the aperture setting on the lens, a change in the camera's frame rate results in a change of the exposure.

ARRI currently provides two methods to compensate for this change in exposure:

- The ARRIFLEX 535 and 435ES are equipped with an electronic shutter that can change its open shutter angle on the fly to compensate for the change in exposure during a speed ramp. The CCU, LCC or RCU are needed to create such speed/shutter ramps. There is no visible change in the depth of field in the picture with this kind of exposure compensation.

- The ICU-1 (Iris Control Unit) can change the lens iris on the fly to compensate for the change in exposure during a speed ramp even on cameras that are not equipped with an electronically adjustable mirror shutter. With the ICU, speed ramps can be performed on the following ARRIFLEX cameras: 535, 535B, 435, 435ES, 35 III, 16SR I, 16SR II, 16SR II HS, 16SR 3, 16SR 3 HS, 765.

5.6.2.1 Setup

- Make sure that the lens motor is tightly attached to the support rods, and that the support rods are tightly locked into the sliding base plate.
- Switch the selector switch on CLM-1 lens motor ⇨ **photo** to IRIS or connect CLM-2 motor to the IRIS socket ⇨ **photo** of the UMC-1.

Note: The lens motors can be adapted to attach either to the 19 mm or to the 15 mm support rods. Make sure you have the correct attachment for the lens motor.

Note: Some older lenses do not have the proper gear on the iris ring. Make sure that all lenses to be used have the proper gear on the iris ring (see chapter 6.7 Iris Gear Rings).

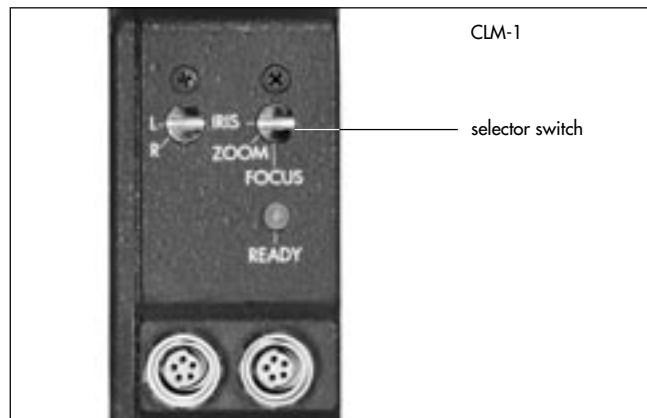
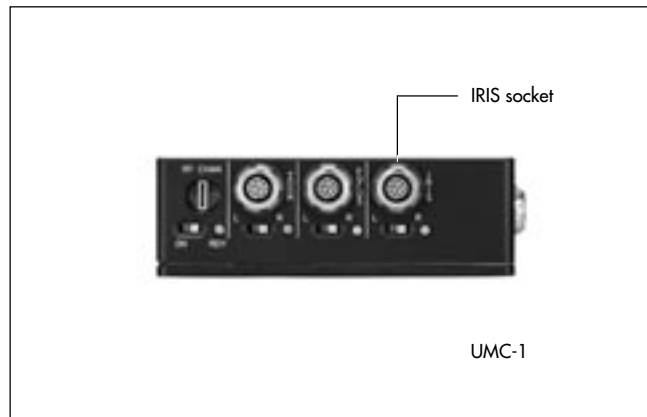

ICU-1 Connecting Cables

The ICU-1 identifies different camera models through different cables.

The ICU-1 and the lens motor are generally powered from the camera, but can also be connected to a separate 12 or 24 Volt battery (with cable LC-S1). The ICU-1 will automatically detect if the incoming voltage is 12 or 24 Volts.

Note: If the camera runs on 12 V, it is recommended to use a separate 24 Volt battery for the ICU-1. The lens motor will be able to respond at a faster rate when connected to a 24V power source.

Note: When powering the ICU-1 and the Motors from the camera, make sure that the maximum load of the used connector on the camera is not exceeded

- Make cable connections according to the diagram. To power the ICU-1 from a separate battery, connect cable LC-S1 to the battery and to the unused connector on the lens motor.

Camera	Camera Cable
ARRIFLEX 535	Connect LC-D1 to RU receptacle
535B	Connect LC-D1 to ACC receptacle
16SR 3	Connect LC-D1 to ACC receptacle
16SR 3 HS	Connect LC-D1 to ACC receptacle
435ES	Connect LC-D1 to RU receptacle Part number: K2.47029.0
ARRIFLEX 35 III	Connect LC-D2 to 11 pin accessory receptacle
435	Part number: K2.47030.0
435ES	
ARRIFLEX 16SR	Connect LC-D4 to 11 pin accessory receptacle
16SR II	Part number: K2.47048.0
16SR II HS	
ARRIFLEX 765	Connect LC-D3 to SCU receptacle Part number: K2.47031.0

ICU-1 cable diagram with CLM-1

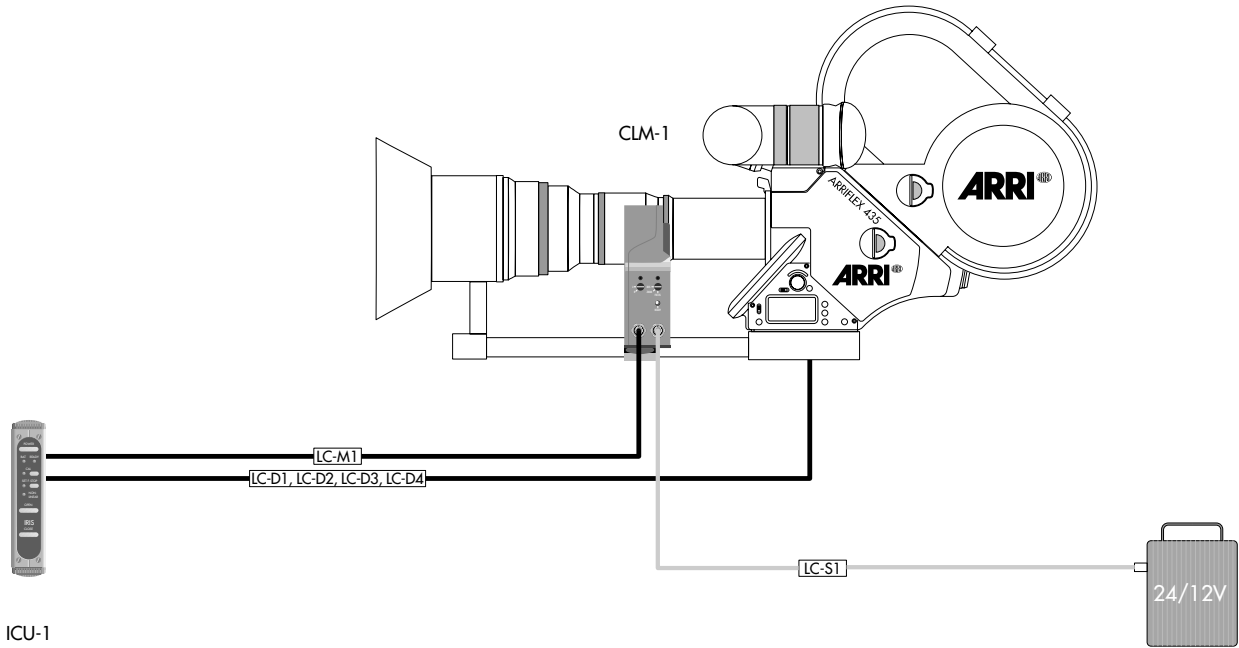

ICU-1 cable diagram with CLM-2

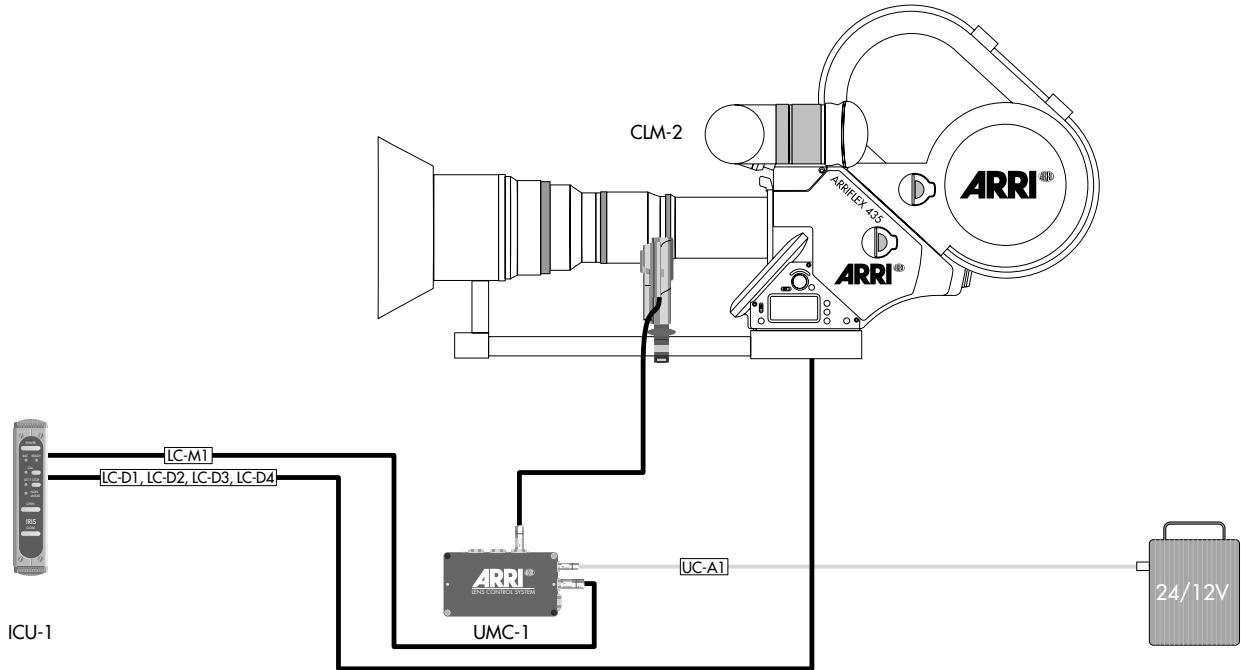

Note: The ARRIFLEX 435ES can be used with cable LC-D1 (9 pin) or with cable LC-D2 (11 pin) since it has both a 9 pin and a 11 pin accessory connector.

Note: Cables for camera models not listed here can be supplied on request.

Note: When using a UMC-1 together with the URM-1 both other lens rings (zoom and focus) can be remotely controlled via the same UMC-1.

Note: The connection of a CLM-1 as a motor for the iris ring on the ICU-1 via a UMC-1 is not possible (and of no use as the direct connection to the motor is also possible).



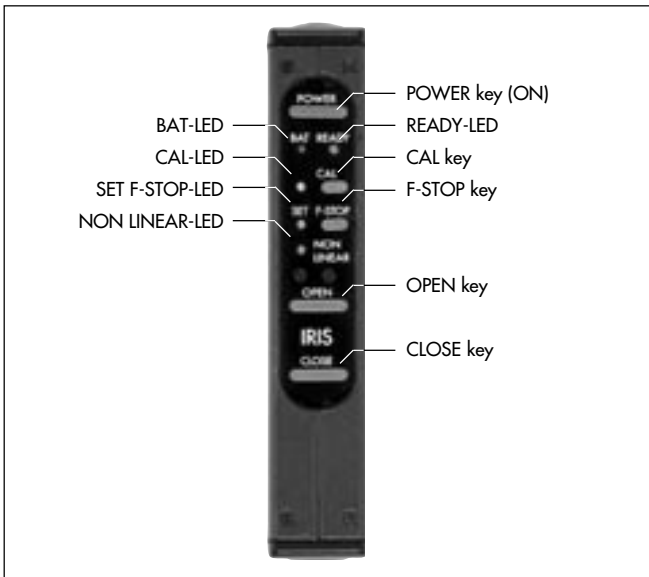

5.6.2.2 Turning ICU-1 Power On

- Push the POWER key → **photo** to switch on the ICU-1.
- The READY LEDs on the ICU-1 and on the lens motor will illuminate briefly and then indicate the system status. See table below.

Setting ICU-1 Reaction Speed

The ICU-1 can be set to a fast or slow reaction speed. This setting determines how fast the ICU-1 reacts to a change in the camera's frame rate.

For most cameras, the fast reaction speed should be used. If you detect a jittering in the lens motor while the camera is running at a constant speed, or a jerky motor movement

ICU READY LED	Camera	ICU	Lens motor
Slow green flashing	Standby	Ready	Ready
Fast green flashing	Ramping up to speed	Set to beginning F-Stop	Ready
Steady green light	Running at speed	Will follow any frame rate changes	Will follow any frame rate changes
Red	See "Trouble Shooting" chapter		
Red/green flashing	See "Trouble Shooting" chapter		

during a speed change, you can change the reaction speed to SLOW, which will reduce these effects.

Note: The minimum ramp duration time for the slow setting is twice as long as for the fast setting. If you need a short ramp duration, use to the fast setting.

To set the ICU-1 reaction speed:

- Turn the ICU-1 power off.
- Turn the ICU-1 power back on while holding down the
 - OPEN button to set the ICU-1 to the fast reaction speed, or the
 - CLOSE button to set the ICU-1 to the slow reaction speed.
- The green SET F-STOP and NON LINEAR LEDs will blink alternately for about 2 seconds in rapid succession if a fast reaction speed is set, and in slow succession if a slow reaction speed is set.

The last reaction speed set in the ICU-1 will remain in memory even if the ICU-1 is turned off.

Note: Lens motors with a serial number smaller than 1190 will always use the fast reaction speed, disregarding of the reaction speed setting on the ICU-1.

Note: Some older ICU-1 models do not have the capability to change the reaction speed. They will always use the fast reaction speed. The ICU-1 can change reaction speeds from software version V0210 on. Older units can be upgraded by your local ARRI service center.

Note: When using the SLOW setting, the minimum ramp times must be doubled – please see the following chapter on calculating the ramp time.

Beginning Frame Rate	Time	Ending Frame Rate
[fps]	[Seconds]	[fps]
3	16	150
4	12	128
5	8	112
6	6	96
7	4	80
8	3	64
10	2	56
12	1.50	48
14	1.00	40
16	0.75	32
20	0.50	28
24	0.25	24
28	0	20
32	0.25	16
40	0.50	14
48	0.75	12
56	1.00	10
64	1.50	8
80	2	7
96	3	6
112	4	5
128	6	4
150	8	3
	12	
	16	

Calculating the Ramp Time



Do not change the camera frame rate abruptly!

The rate of the permissible camera fps change depends on the beginning frame rate and the acceleration characteristics of the lens motor. The ramp time set should not be below the calculated minimum!

All values given here are for the fast reaction time setting. The minimum change time should be doubled if the reaction time is set to SLOW.

The minimum change time can be calculated using the following formula:

$$t = \frac{(V_2 - V_1)}{4 V_1}$$

t Minimum ramp time (in seconds)

V₁ Beginning frame rate for a positive ramp or ending frame rate for a negative ramp (in fps)

V₂ Ending frame rate for a positive ramp or beginning frame rate for a negative ramp (in fps)

Note: A "positive" ramp is a frame rate change to a higher fps value. Example: 10 to 50 fps.
A "negative" ramp is a change to a smaller fps value. Example: 50 to 10 fps.

The approximate minimum ramp time can also be derived from the nomogram. To calculate the minimum ramp time, connect the two camera frame rates with a straight line and read the time at the intersection of that line and the time scale.

For example, if ramping from 12 to 48 fps, the ramp should not be shorter than 0.75 seconds.

To shorten the ramp duration when a large fps range is covered, the ramp can be broken up into separate smaller ramps. These can be run consecutively.

For example, if ramping from 4 to 96 fps, 6 seconds would be the minimum time. But if ramping:

- from 4 to 16 fps, the minimum ramp time is 0.75 seconds, and if then ramping
- from 16 to 96 fps, the minimum ramp time is 1.25 seconds.

Combined, the new minimum time is only 2 seconds. Consecutive frame rate ramps can be created with an external camera controller like the LCC.

Changing camera frame rate manually with VSU:
Multiply derived minimum ramp time by 3 to be sure that possible uneven speed change of the ramp is not critical.

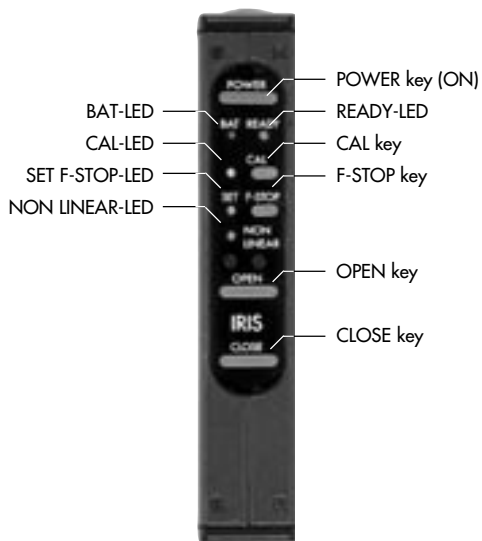

ICU-1 Calibrating

During calibration the ICU-1 learns and memorizes the end-stops of the iris ring to avoid the mechanical stress of driving the ring all the way to the end. Any previously stored end-stops will be erased during calibration.

You should calibrate the ICU-1:

- when setting up
- after a lens change
- after having moved the iris ring while the ICU-1 was switched off
- after the lens motor and the iris ring gear have been separated
- if the CAL-LED flashes.

- Push the CAL key ⇨ **photo** on the ICU-1. While the ICU-1 is calibrating, the yellow CAL-LED will be illuminated.



If the CAL LED flashes: End stops have not been defined yet or the lens ring has been turned while the ICU-1 was switched off and then been driven to an end-stop. Repeat calibration process!

Note: Pay specific attention to the gears when calibrating. Sometimes the gears can slip because they do not mesh closely enough, or the lens motor is not clamped down tight enough on the support rods, or the support rods are not clamped tightly enough on the bridge plate. If this happens, re-tighten everything. In extreme cases it helps to push the lens motor towards the lens while calibrating. This is only an issue during calibration, as the ICU-1 uses a lot of torque during calibration.

Setting the ICU-1 Lens Motor Drive Direction

The ICU-1 can perform the proper iris correction only if the lens motor drive direction corresponds to the OPEN and CLOSE keys.

- Check the current lens motor drive direction by pushing the OPEN and CLOSE key on the ICU. The iris should open when the OPEN key is pushed, and close when the CLOSE key is pushed. If that is not the case, switch the drive direction switch (labelled L/R) on the CLM-1 lens motor ⇨ **photo**, or on the UMC-1 ⇨ **photo** for CLM-2 lens motors.

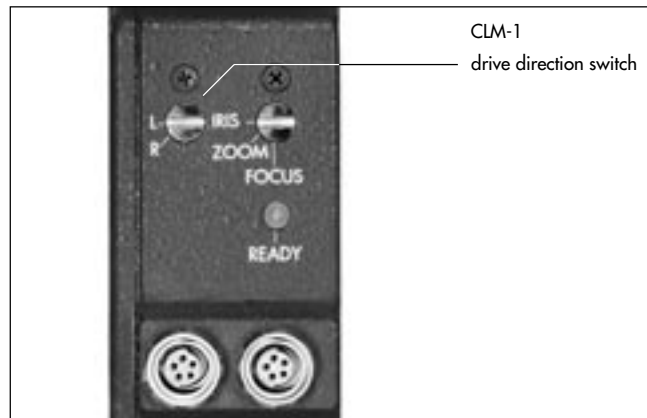
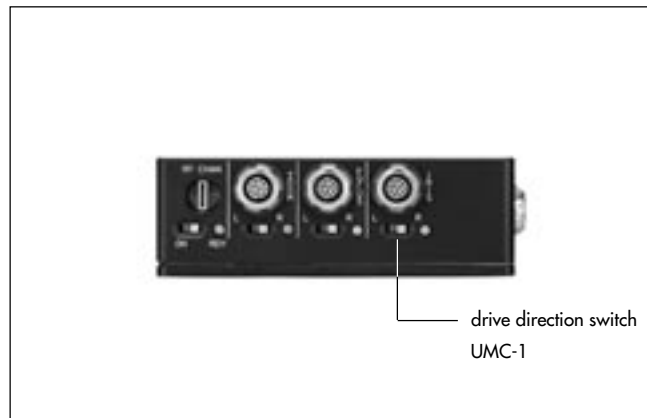

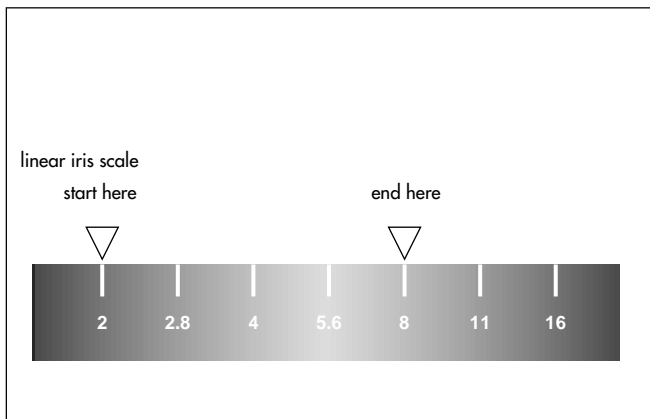
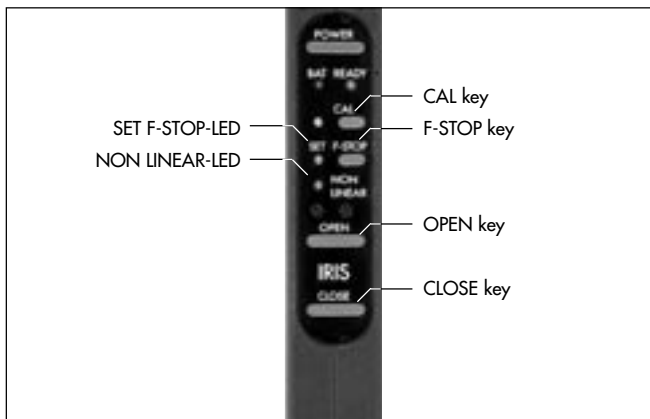

Assigning F-Stops with the ICU-1

The ICU-1 has to be taught where on the iris ring the F-Stops are. There are two different methods for two different types of iris scales:

- A **linear** iris scale is an iris scale where each F-Stop is exactly the same distance from the next one. Zeiss Standard Primes, Super Speed Primes and Variable Primes have a linear iris scale, for example. Assigning F-Stops for a linear iris scale is a one step procedure.
- A **non-linear** iris scale is an iris scale where the distances between the F-Stops differ. The Angenieux 25-250HR has a non-linear iris scale, for example. Each F-Stop will have to be assigned individually for a non-linear iris scale.

Assigning F-Stops

for a lens with *linear* iris ring markings:

- Use the OPEN and CLOSE keys ⇨ **photo** to precisely position the iris ring either at the largest or at the smallest **full** F-Stop.
- Push the F-STOP key ⇨ **photo** and keep it pushed down. Use the OPEN and CLOSE keys to move the iris ring four F-Stops further. If you are at a T 2.8, for instance, you should go to a T 11 (see graphic). The SET F-STOP LED will flash while you move the lens ring.
- Release the F-STOP key. The SET F-STOP LED ⇨ **photo** will illuminate to indicate that a linear iris scale has been memorized.

Assigning F-Stops

for a lens with *non-linear* iris ring markings:

- Use the OPEN and CLOSE keys ⇨ **photo** to precisely position the iris ring either at the largest or at the smallest **full** F-Stop.
- Push the F-STOP key ⇨ **photo** and keep it pushed down.
- Use the OPEN and CLOSE keys to set the iris ring to each F-Stop. At each F-Stop push the CAL key ⇨ **photo** briefly.

Do not go to the end positions unless they represent a full F-Stop change from the last F-Stop marking. The NON LINEAR LED ⇨ **photo** flashes while you read the F-Stops. You can assign a minimum of two and a maximum of twelve F-Stops.

- Release the F-STOP key. The NON-LINEAR LED ⇨ **photo** illuminates and thus indicates that the settings are valid. If the NON-LINEAR LED stops blinking or does not illuminate, the settings have not been memorized properly. Then you must repeat the procedure.

Note: When assigning F-Stops on both linear and non linear scales, use only full F-Stops! The widest open F-Stop on many lenses, for example, is **not** a full F-Stop. The most common full F-Stops are:
1, 1.4, 2, 2.8, 4, 5.6, 8, 11, 16, 22, 32, 45.

Verify Operation

- Run the camera without a magazine attached.
- Use your speed controller to change the speed from 24 to 48 fps. Watch the lens iris ring: it should open up one stop.

Resetting after a Lens Change

- Swing the lens motor back onto the iris ring and tighten it. Make sure that the lens motor gear meshes with the iris ring gears without any play.
- Make sure that the lens motor is tightly attached to the support rods, and that the support rods are tightly locked into the sliding base plate.
- Switch the ICU-1 on.
- Calibrate the ICU-1.
- Assign F-Stops.

If the Iris Ring Moves While Power is Off

If the iris ring is moved while the ICU-1 is switched off, the end positions memorized in the ICU-1 and the actual end positions of the iris ring will no longer be the same!

- Switch the ICU-1 on and re-calibrate.
It is not necessary to assign new F-Stops.

5.6.2.3 Operating the ICU-1

Before starting the camera, the beginning frame rate and the corresponding F-Stop have to be set. Once the camera is running, the ICU-1 will remember the beginning frame rate and F-Stop. It will then correct the iris for any change in the camera's frame rate. Once the camera is stopped the ICU-1 will set the iris back to the beginning F-Stop.

The ICU-1 will interpolate all F-Stop values that fall in between two full F-Stops. For linear iris rings, the ICU-1 will use those interpolated values in the space between the last F-Stop and the end position of the iris ring. For non linear iris rings, the ICU-1 will extrapolate based on the values from the last full F-Stop and use the results in the space between the last F-Stop and the end position of the iris ring.

The ICU will remember its calibration and the assigned F-Stops even when it is switched off.

- Set the ICU-1 up as described in the previous chapter.
- Set the beginning frame rate on the camera.
- Set the beginning F-Stop with the ICU-1.
- Start the take.
The ICU-1 will be ready one second after the camera has reached speed. If the frame rate of the camera changes during the take, the ICU-1 will automatically compensate for the change in exposure by changing the iris accordingly.

Note: The ICU-1 will lock all operating buttons while the camera is running to prevent unintentional operation of those buttons.

Operating the ICU-1 with the ARRIFLEX 535 or 435ES

The ARRIFLEX 535 and 435ES cameras can be programmed with the RCU-1, the LCC or the CCU to perform simultaneous frame rate and mirror shutter changes to compensate for differences in exposure during speed ramps.

To use the ICU-1 during a frame rate change on these cameras, the mirror shutter must be programmed to remain constant, i.e. kept at the same angle through the whole frame rate change!

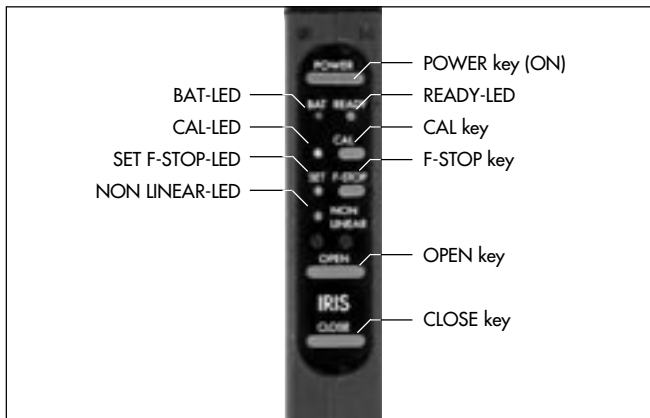

Setting a F-Stop

To open or close the iris:

- Push the OPEN or CLOSE key → **photo**.
The lens motor will move the iris ring as long as one of these buttons is pushed. If a button is pushed for a long duration, the lens motor will increase the rate of change. If the button is released, the speed of change will be set back to the slower value.

Momentary Opening of the Iris (ZAP)

- To open the iris temporarily, push the zap key → **photo** located on the ICU-1 back side, underneath the connectors.

The iris will remain open as long as the zap button is pushed. When the zap button is released, the ICU-1 will return to exactly the same position it was in before the zap button was pushed.

Note: This feature is disabled while the camera is running!

ICU-1 and Variable Primes

When using the ICU with the Variable Primes, make sure that the iris ring does not move in the area between T-22 and CLOSE. An improper exposure would result.

ICU-1 Battery LED

- Replace the battery when the battery LED (labelled BAT) illuminates or flashes.



Do not start any new scenes!

- Immediately replace the battery when the battery LED flashes. Otherwise, you run the danger of deep discharging the battery.

The battery LED reacts to the following voltage limits:

Main Voltage	BAT Indicator	Actual Voltage
24V	illuminated	< 20 V
	flashing	< 18 V
12V	illuminated	< 10 V
	flashing	< 9 V

ICU-1 Main Fuse

The main fuse is a self resetting thermal fuse. If it blows due to an error, remove the cause of that error and let the fuse reset itself. Under normal conditions it will reset in five to ten seconds. High outside temperature or a severe error will prolong the resetting time.

Note: If you suspect a blown fuse while using the ICU-1 with the ARRIFLEX 535A, 535B, or early models of the 16SR 3, make sure to also check the camera's accessory fuse!
 Later models of the 16SR 3 and the 435 and 435ES are equipped with self resetting thermal fuses. The same method for resetting applies.

Button Lock During Run

The ICU-1 will lock all buttons while the camera is running. If a locked button is pushed, the ICU-1 will show a red LED as long as that button is pushed.

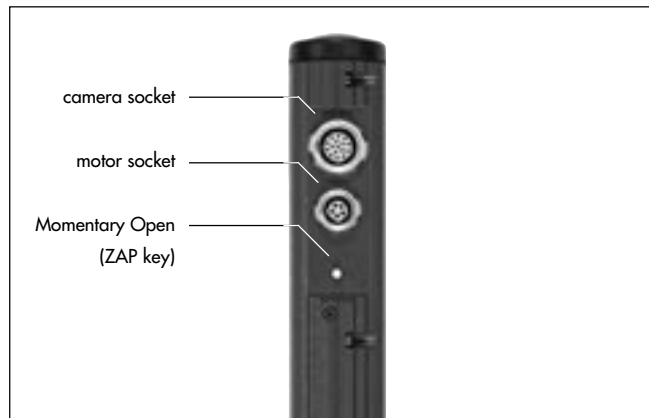



Steadicam configuration

6. Mechanical Accessories

6.1 Mounting on Ø 15mm Support Rods

The motor units can also be mounted on Ø 15mm support rods.

Replace the offset clamp unit on the CLM-1

- Remove the two screws on the bottom of the motor unit and the screw on the side → **photo**.
- Replace clamp unit.
- Replace screws.

Order number for the clamp unit: K2.41379.0



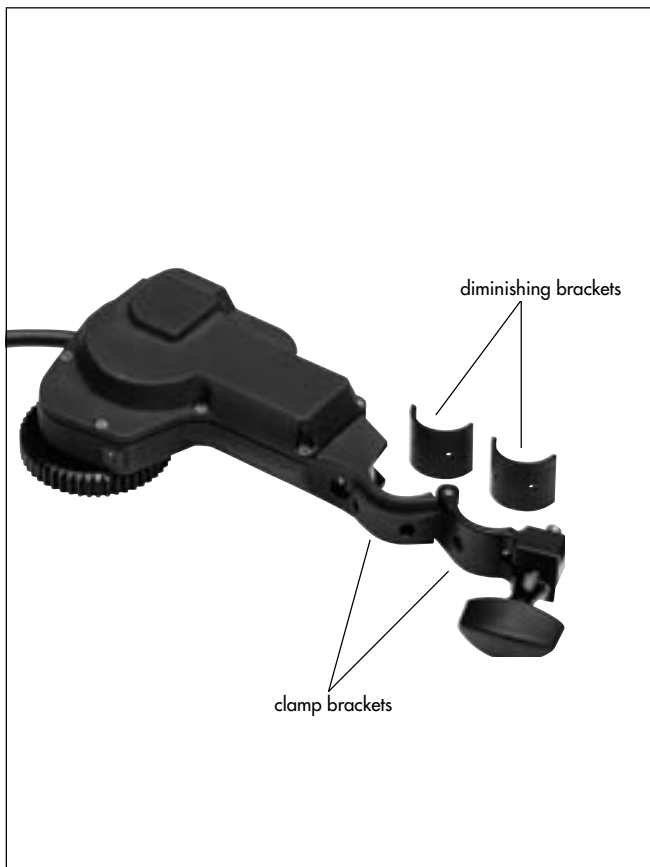

Mounting diminishing brackets on the motor unit CLM-2

- Flip up the clamp brackets ⇨ **photo** on the motor unit CLM-2.
- Place the diminishing brackets ⇨ **photo** into the clamp bracket of the motor unit CLM-2.
- Fasten the diminishing brackets with two screws each.

Mounting the diminishing brackets on the console

- Flip up the locking lever ⇨ **photo** and unscrew the ballcatch ⇨ **photo** with a screwdriver until it completely disappears in the bracket.
- Push the diminishing tube with the slit ⇨ **photo** flush into the console socket ⇨ **photo**, ensuring that the slit in the tube corresponds with the clamp slit.
- Fix the diminishing tube with two screws from the outside.

- Push the tube \varnothing 15mm flush into the diminishing tube on the console. Ensure that the slit  in the tube points in the direction of the ballcatch.
- Screw the ballcatch out of the bracket until the tube can no longer be pushed out of the bracket.
- Turn the locking lever until a slight resistance can be felt, then press the lever downwards.
- Flip up the clamp brackets.
- Place the diminishing brackets into the clamp brackets.
- Secure the diminishing brackets with two screws each.

Order number for the console: K2.52035.0

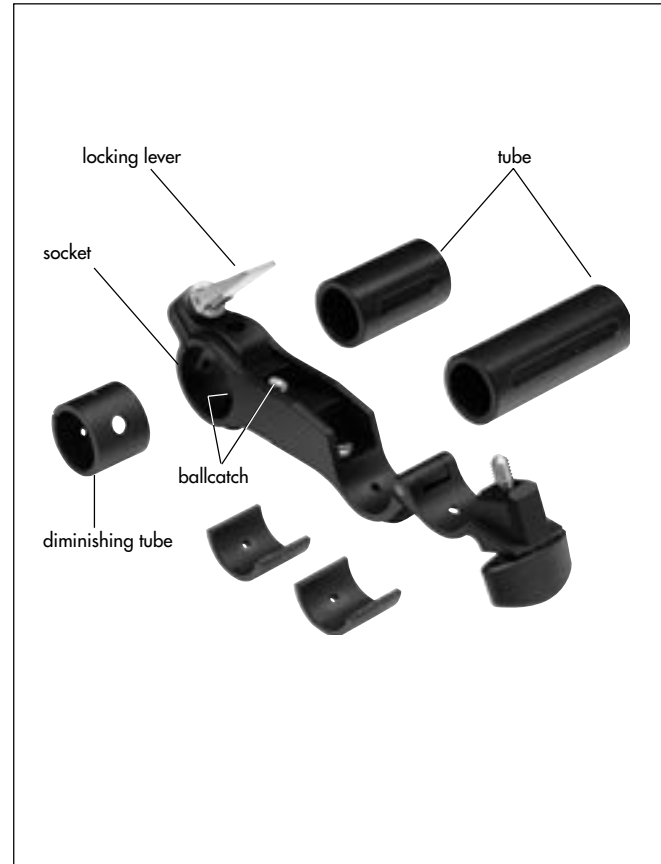



6.2 Offset Mounting

If the motor unit CLM-1 is to be used on a short lens, a different offset clamp unit should be mounted to reach the iris control ring of the lens.

Order numbers:

K2.41381.0 for \varnothing 19mm rods

K2.41380.0 for \varnothing 15mm rods

To replace the offset clamp unit

- Remove the two screws on the bottom of the motor unit and the screws on the side ⇨ **photo**.
- Replace clamp unit.
- Replace screws.

6.3 Panhandle Holder

The zoom unit can be used with a panhandle holder on the following SACHTLER fluid heads:

- Video 17III_25II
- Horizon II
- Studio II
- Dutch Head
- Studio 80

The zoom unit can also be used with the panhandle holder on fluid heads of other manufacturers.

Order number: K2.44809.0

6.4 Motor Holder for ARRIFLEX 35 III

If the motor unit is to be used with the ARRIFLEX 35 III with a short lens, a special motor holder is necessary in order to reach the iris control ring.

Order number: K2.41390.0

Mounting the motor holder

- Mount the motor holder instead of the standard carrying handle.
- Mount the motor unit onto the motor holder.



Motor unit with the movable iris drive gear mounted on the ARRIFLEX 35 III

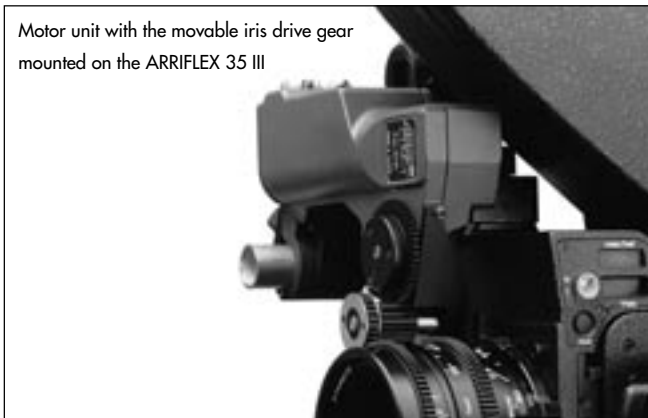

6.5 Movable Iris Drive Gear

On lenses where the iris control ring moves laterally when the lens is being focused, the iris drive gear must move with it. To enable this, the motor unit CLM-1 or CLM-2 is equipped with a movable iris drive gear which allows the iris ring to move 15 mm.

Order number: K2.41388.0

Mounting the Movable Iris Drive Gear

- Replace the original standard motor unit drive gear with the narrow gear (included in the conversion kit).
- Mount the movable iris drive gear with two screws onto the standard motor unit → **photo**.



Before calibration of the LCS unit, ensure that the lens ring is engaged properly in the movable iris drive gear. Otherwise damage to the lens or the LCS can occur.

6.6 Iris Drive Gear

To enable greater adjustment speeds, gears with a larger diameter are available. Gears for use on video camera lenses are also available.

Order numbers:

K5.52457.0	Gear for motion picture camera lenses with large diameter (65 teeth)
K5.52049.0	Gear for video camera lenses (module 0.5 104 teeth)
K5.52051.0	Gear for video camera lenses (module 0.5 80 teeth)

6.7 Iris Gear Rings

Retrofit iris gears are available for the following older lenses that were not available with integrated iris gear rings.

Order numbers:

K2.43351.0	for Zeiss Vario-Sonnar T2.0, 10-100mm and for Zeiss Vario-Sonnar T2.2, 11-110mm
K2.44925.0	for Zeiss standard lenses
K2.44811.0	for 35mm High Speed Zeiss T1.3
K2.44833.0	for 16mm High Speed Zeiss T1.3 and for standard Zeiss 180mm
K2.44835.0	for Cooke Cine Varotal T4.0, 25-250
K2.44863.0	for Cooke T1.6, 10-30 and for Cooke T3.1, 20-60
K2.44925.0	for Angenieux T2.9, 20-120
K2.44928.0	for Angenieux T3.9, 25-250

7. Trouble-Shooting

7.1 Power Supply

Problem	Cause	Remedy
No Reaction when switched on	Battery empty	Check battery level
	camera switched off	When power is supplied through camera, switch it on
	Main fuse defective	Replace fuse in the LC-S1, S2, S3, S4. The UMC-1 is equipped with self-resetting fuses Switch off, wait several seconds, switch on
	Power cable LC-S1, S2, S3, S4 defective	Connect power cable LC-S1, S2, S3, S4 directly to the zoom unit and press POWER key. If no reaction, replace power cable
	Power cable UC-A1 or UC-S1 defective	Replace power cable
	Zoom cable LC-Z1 or LC-Z2 defective	When using several motor units, connect zoom cable directly to the motor unit to which the power cable LC-S1 is also connected. If no reaction, replace zoom cable. Otherwise replace motor cable.
	Motor cable LC-M1 or LC-M2 defective	

7.2 UMC-1 Universal Motor Controller LEDs

Problem	Cause	Remedy
READY LED illuminated red	Operating error on the UMC-1 (radio channel was altered while switched on, an attempt was made to switch off the UMC-1 while the camera was running)	go back to prior status
	URM-1 with same radio channel active	select another radio channel
Motor LED illuminated red	ZMU-1 or WMU-1 is switched off	switch on ZMU-1 or WMU-1
	UMC-1 was switched on after ZMU-1 or WMU-1	switch ZMU-1 or WMU-1 off and on again
	CLM-2 motor unit was connected after switching on ZMU-1 and/or WMU-1	switch off ZMU-1 or WMU-1 and UMC-1, switch on again and recalibrate the system
Motor LED flashes red	Several motor units are set to the same operational function or plugged into the UMC-1. The READY LEDs on the manual control units also flash red	switch off, set selector switch on each motor unit CLM-1 to the corresponding function, or plug CLM-2 motor units into the corresponding position. Switch on.
	CLM-2 motor unit defective	replace CLM-2 motor unit

7.3 CLM-1 Motor Unit LEDs

Problem	Cause	Remedy
READY LED flashes red	Several motor units are set to the same operational function or plugged into the UMC-1. The READY LEDs on the manual control units also flash red	switch off ZMU-1, WMU-1 and UMC-1. set selector switch on the motor units to the corresponding function, switch on.
	Motor cable LC-M1 or LC-M2 defective	check all motor cables and replace if necessary
READY-LED illuminated red	Operational error, e.g. selector switch on motor unit was operated while the unit was switched on	reset to original setting switch off ZMU-1, WMU-1 and UMC-1, check settings on control units and motor units, switch on
	Power cable LC-S1 defective	Replace power cable

7.4 WMU-1 Wireless Main Unit LEDs

Problem	Cause	Remedy
WMU-1 cannot be switched on	During calibration no extra WMU-1 can be switched on	wait until calibration is finished
READY-LED flashes red	Incorrect configuration	switch off, set selector switch on motor units CLM-1 to correct position, or attach motor unit CLM-2 to the correct socket on the UMC-1, or turn selector switch on the WFU-1 to the corresponding function, switch on
READY-LED illuminated red	Operating error on a control unit (e.g.selector for radio channel was changed)	reset to original setting switch off, check settings on control unit, switch on
	Use of a locked control element, e.g. SET key while camera is running	perform all functions in proper sequence
	UMC-1 is switched off	switch on UMC-1, switch WMU-1 off and on
	UMC-1 was switched on after WMU-1	switch WMU-1 off and on

Problem	Cause	Remedy
RF-LED briefly illuminates red	Short disturbance (loss of a data packet)	with no effect on lens positioning to prevent further disturbances, reduce distance between WMU-1 and URM-1
RF-LED flashes red	No radio contact for over a second (danger of incorrectly set lens)	reduce distance between WMU-1 and URM-1
RF-LED is dark	Radio module was switched off (to save energy)	<p>configurational error, or no suitable motor available</p> <p>radio contact was interrupted for over 40 seconds (unit switches on again when an operational element is touched)</p>
CAL-LED flashes	Motor units were replaced or moved. After switching on again, the end stops are incorrect	recalibrate
	Stops not yet defined or the lens ring has been moved with the LCS switched off and was then driven against the lens' end stop.	recalibrate

Problem	Cause	Remedy
CAL-LED flashes	Lens ring does not move freely	Manually check for damage of lens ring
Battery Control (BAT)	illuminated - Battery nearly empty	WMU-1 will work for approx. 15 min
	Flashing	WMU-1 will work for approx. 5 min Battery empty, replace battery Do not start any new scenes!
	Flashing quickly	WMU-1 will switch off in approx. 5 s Battery empty, replace battery immediately Do not start any new scenes!

7.5 WZU-1 Wireless Zoom Unit LEDs

Problem	Cause	Remedy
LENS-LED illuminated red	The WZU-1 is not active (has no control over a motor)	a different unit (ZMU-1 or WZU-1) already has control over the lens zoom ring.
	No zoom motor available	attach zoom motor

7.6 WFU-1 Wireless Focus Unit LEDs

Problem	Cause	Remedy
LENS-LED (slider) illuminated red	<p>no motor unit installed for slider</p> <p>The slider on the WFU-1 is not active (has no control over a motor)</p>	<p>install motor for slider</p> <p>a different WFU-1 has the control over the lens ring operated by the slider. If a different WFU-1 is switched on, and its handwheel is aligned to the same ring as the slider, this WFU-1 has control.</p>
LENS-LED (handwheel) illuminated red	<p>no motor unit installed for handwheel</p> <p>The handwheel on the WFU-1 is not active (has no control over a motor)</p>	<p>install motor for handwheel</p> <p>A different WFU-1 already has control of the aligned lens ring. The first unit switched on always has control. Exception: the FIU-1 units always lose control when a WFU-1 is switched on.</p>

7.7 ZMU-1 Zoom Main Unit LEDs

Problem	Cause	Remedy
READY-LED flashes red	Incorrect configuration	switch off, set selector switch on motor units CLM-1 to the correct position, or connect motor unit CLM-2 to the correct socket on the UMC-1, switch on
	UMC-1 is switched off (READY-LEDs on FIU-units flash red)	switch on UMC-1, switch zoom unit off and on
	UMC-1 was switched on after the zoom unit	switch zoom unit off and on
	No motor unit connected	connect motor unit
	Motor cable LC-M1 or LC-M2 or focus cable LC-F1 or LC-F2 defective	check all motor cables and focus cables and replace if necessary
READY-LED illuminated red	Use of a locked control element, e.g. SET key, while calibrating	perform all functions in proper sequence
	Operating error on a control unit	Switch off, check settings on control units, switch on

Problem	Cause	Remedy
CAL-LED flashes	<p>Motor units were replaced or moved. After switching on again, the end stops are incorrect</p>	recalibrate
	<p>Stops not yet defined or lens was moved while LCS was switched off and then driven against the stop</p>	recalibrate
	<p>Lens ring does not move freely</p>	Check for damage of lens ring and movability
Battery Control (BAT) illuminated	Battery nearly empty	<p>Replace battery Do not start any new scenes!</p>
Battery Control (BAT) flashes	Battery empty	<p>Replace battery immediately; danger of deeply discharging</p>

7.8 FIU-1 Focus/Iris Unit LEDs

Problem	Cause	Remedy
READY-LED flashes red	Incorrect configuration	switch off, set selector switch on motor units CLM-1 or on the FIU-1 to the correct position, or connect motor unit CLM-2 to the correct socket on the UMC-1, switch on
	Motor unit not connected	Connect motor unit
	Motor cable LC-M1 or LC-M2 or focus cable LC-F1 or LC-F2 defective	Check all motor cables and focus cables and replace if necessary
READY-LED flashes red / green	another WFU-1 took over control	check configuration
READY-LED illuminated red	Use of a locked control element, e.g. SET key while calibrating	perform all functions in proper sequence
	Operating error on one control unit e. g. focus or iris handwheel was moved during calibration	wait for calibration to end
CAL-LED flashes	Motor units were replaced or moved. After switching on again, the end stops are incorrect	recalibrate

Problem	Cause	Remedy
CAL-LED flashes	Stops not yet defined or lens was moved while LCS was switched off and then driven against the stop	recalibrate
	Lens ring does not move freely	check for damage of lens ring and movability

7.9 ICU-1 Iris Control Unit LEDs

Problem	Cause	Remedy
READY LED flashes red	Camera cable shows invalid camera ID	use correct cable
	No lens motor or more than one have been set to IRIS	only one motor unit must be set to IRIS
READY LED illuminated red	A locked button has been pressed	all buttons are locked while camera is running
READY LED flashes green/red	The Lens motor has reached a lens end-stop while the camera was running. (even if the CLM is positioned no longer at the end stop)	the LED will flash until any button is pressed to reset it.

Problem	Cause	Remedy
READY LED flashes green/red	The OPEN or CLOSE button has been pressed while the motor was at an end position	avoid operational errors
	Calculated F-Stop is outside of the range of the iris ring	iris compensation not possible
CAL LED flashes	End stops are invalid	calibrate
	Iris ring has been turned while the ICU was switched off and then been driven to an end-stop.	recalibrate
	Iris ring moves with difficulty or is stuck/gears may mesh too tightly	Clean or readjust
BAT illuminated red	Battery voltage low	change battery, do not start a new take
BAT red flashing	Battery voltage very low	change battery immediately danger of deeply discharging the batty do not start a new take

8. Index

- A**
- accessories
 - mechanical 97
 - radio unit 57
 - adjustment range
 - defining 53, 69
 - erasing 53, 56, 70
 - antenna 30
 - ARRI service 128
- B**
- ballcatch 28, 98
 - BAT 63
 - LED 41, 63, 95
 - LED signals 41
 - LED status 95
 - battery 42
 - charger 13
 - charging 43
 - control 41, 63
 - voltage limits 63
 - battery WBU-1/WBU-2 13
 - belt clip 59
 - break 41
- C**
- cable remote control 17, 61
 - cables 15
 - cables table 23
 - CAL
 - key 40, 45, 62, 64, 88
 - LED 45, 64, 88
 - calculating the ramp time 86
 - calibration 40, 45, 48, 52, 64
 - camera RUN 46, 67
 - charger 13
 - CLM-1 11, 23, 62, 79, 89
 - attaching 26
 - offset clamp unit 97
 - CLM-2 11, 23, 79, 89
 - attaching with/without console 28
 - diminishing bracket 98
 - CLOSE key 85, 89, 91, 94
 - code for identifying components 9
 - console CLM-2 28
 - console diminishing bracket 98
 - contents 3
 - control units
 - attaching and connecting 33
 - controlled lens motor 11
 - controller 11

- D**
- defining the lens setting range 48, 53, 56, 65, 69
 - diagram
 - cables 23
 - examples of use 18
 - ICU-1 cable 80
 - motor cabling and supply 33
 - ramp time calculation 86
 - system overview 17
 - diminishing bracket 98
 - diminishing tube 98
 - display
 - status 40
 - dovetail adapter 31
 - drive direction 26, 30, 40, 62, 89
 - drive gear iris 103
- E**
- end stops 40, 41, 45, 47, 48, 51, 52, 55, 62, 63, 64, 70, 88
 - mechanical 53
 - examples of use 18
 - extended break 41
- F**
- F-STOP**
- assigning 90, 91
 - full f-stops 91
 - key 91
 - LED 85, 91
 - FIU-1 15
 - defining the function 68
 - focus or iris setting 69
 - operating 68
 - focal distance 65
 - focus adjustment 52
 - focus disks 53, 54
 - focus iris unit 15
 - operating 68
 - focus scale disks 53, 70
 - focus unit 13
 - follow-focus device
 - mechanical 53
- G**
- gear rings iris 103

- H**
- handwheel 50, 52, 53, 54, 69, 70
 - determining if it controls focus or iris 52
 - fixing 53, 69
 - operating 52
- I**
- ICU-1 15, 77
 - assigning F-Stops 90
 - battery LED 95
 - cable diagram 80
 - cable diagram with CLM-1 81
 - cable diagram with CLM-2 82
 - calibrating 88
 - connecting cables 80
 - drive direction 89
 - locking operating keys 95
 - main fuse 95
 - operating 93
 - operating with the 535 and 435 94
 - operating with the Variable Primes 94
 - reaction speed 84
 - resetting after a lens change 92
 - setting a f-stop 94
 - setup 79
 - status 84
 - switching on 84
 - iris adjustment 52
 - iris control unit 15, 77
 - iris drive gear 103
 - iris drive gear movable 102
 - iris gear rings 103
 - iris scale
 - linear 90
 - non-linear 90
 - IRIS socket 79

- K**
- key
 - CAL 40, 45, 62, 64, 88
 - CLOSE 85, 89, 91, 94
 - F-STOP 91
 - KNOB 53, 54, 70, 71
 - LENS 48, 49, 53, 56, 69, 70
 - MEM 73, 76
 - ON 39, 42, 47, 51, 58
 - OPEN 85, 89, 91, 94
 - PLAY 74, 76
 - POWER 61, 84
 - REC 73, 75
 - RUN 46, 67
 - SET 65
 - ZAP 49, 66, 94
 - KNOB
 - key 53, 54, 70, 71
 - LED 53, 54, 70, 71
- L**
- laterally moving gears 29
 - LED
 - BAT 41, 63
 - CAL 45, 64, 88
 - F-STOP 85, 91
 - KNOB 53, 54, 70, 71
 - LENS 48, 49, 53, 56, 69
 - NON-LINEAR 85
 - PLAY 74, 76
 - POWER SUPPLY 44
 - READY 40, 62, 76, 84
 - REC 73, 75
 - RF 38
 - RUN 46, 67
 - SET 65
 - LENS
 - key 48, 49, 53, 56, 69, 70
 - LED 48, 49, 53, 56, 69
 - lens motor 11
 - lenses with laterally moving gears 29
 - linear iris scale 90
 - locking lever 28, 42, 98
 - locking screw
 - handwheel 53
 - slider 55

- M**
- manual control units 17
 - attaching and connecting 33
 - for cable remote control 61
 - for radio control 35
 - matching the scale range on the FIU-1 70
 - maximum adjustment speed 55, 69
 - mechanical accessories 97
 - mechanical follow-focus drives 54, 70, 71
 - MEM key 73, 76
 - memory
 - bank 74
 - bank indicators 73
 - module 72
 - module playback 74
 - module recording 73
 - motor 11, 23
 - attaching and connecting 23, 26
 - cabling 33
 - CLM-1 23
 - CLM-2 23
 - selection and power supply 23
 - motor controller 11
 - motor holder for ARRIFLEX 35 III 101
 - motor units 17
 - movable iris drive gear 102
- N**
- negative ramp 87
 - NON LINEAR LED 85
 - non-linear iris scale 90
- O**
- offset clamp unit 97
 - offset mounting 100
 - ON key 39, 42, 47, 51, 58
 - OPEN key 85, 89, 91, 94
 - operating several units 56
 - operation 35
- P**
- panhandle holder 101
 - PLAY key 74
 - PLAY-LED 74, 76
 - playback 76
 - positive ramp 87
 - POWER key 61, 84
 - power supply 15
 - LED 44

- R**
- radio channel
 - countries 36
 - selecting 36
 - setting 36
 - radio connection
 - distance 38
 - quality 38
 - radio control
 - manual control units 35
 - radio module 11
 - radio operation 30
 - radio remote control 17, 35
 - switching on 39
 - radio unit accessories 57
 - ramp
 - combined 87
 - negative 87
 - positive 87
 - time calculation 86
 - time diagram 86
 - reaction speed ICU-1 85
 - READY
 - LED 40, 62, 76, 84
 - LED status 62
 - REC
 - key 73, 75
 - LED 73, 75
 - release key 47, 58
 - remote control via cable 17, 61
 - remote control via radio 17
 - remote-RUN 46, 67
 - resuming operation after an extended break 41, 63
 - RF-LED 38
 - RUN 46, 67
 - key 46, 67
 - LED 46, 67

- S**
- safety specifications 7
 - scale range
 - erasing 54, 71
 - marking 53
 - matching 53
 - scales from mechanical follow focus drives 54
 - selector switch 26
 - SET
 - key 65
 - LED 65
 - setting range
 - defining 69
 - erasing 53, 56, 70
 - setup 23
 - slider 50, 55
 - fixing into position 55
 - SLOW 85, 86
 - speed ramp overview 77
 - status display 40
 - stops 50
 - support rods \varnothing 15mm 97
 - switching on radio remote control 39
 - symbols, meaning of the 7
 - system components 9
 - system overview 9, 17
 - diagram 17
- T**
- table
 - cables 23
 - ICU-1 cables 80
 - technical data 125
 - trigger function 75
 - trouble-shooting 105
- U**
- UMC-1 11, 30, 31, 35, 39, 61, 64, 79, 89
 - attaching to the camera 31
 - universal motor controller 11, 30, 35, 61
 - universal radio module 11, 30, 35
 - URM-1 11, 30, 31, 35, 36, 39
 - attaching to the UMC-1 30
- V**
- voltage limits 63
- W**
- WAC-1 13, 43, 44
 - WBU-1 13
 - charging 43
 - replacing 42
 - WBU-2 13
 - charging 43
 - replacing 42

- WEU-1 13, 57
 - attaching 58
 - WFU-1 13, 35, 39, 50, 57
 - attaching to the WMU-1 51
 - handwheel 52
 - main operating elements 50
 - operating 50
 - several units WFU-1 50
 - slider 55
 - switch 50
 - WHA-1 57
 - wireless accumulator charger 13, 43
 - wireless battery unit 42
 - replacing 42
 - wireless extension unit 13, 57
 - attaching 58
 - wireless focus unit 13, 35
 - operating 50
 - wireless handgrip attachment 57
 - wireless main attachment 57
 - wireless main unit 13, 35
 - operating 36
 - wireless zoom unit 13, 35
 - operating 47
 - WMA-1 57
 - WMU-1 13, 35, 36, 39, 40, 42, 45, 57
 - operating 36
 - WZU-1 13, 35, 39, 57
 - mounting 47
 - operating 47
- Z**
- ZAP
- function 49, 66
 - key 49, 66, 94
- ZMU-1 15, 40, 61, 62, 68
 - operating 61
- zoom 48, 65
 - defining the range 48, 65
 - erasing the defined range 49, 65
 - lever 48, 65
 - range 48
 - redefining the range 65
 - sensitivity 49, 66
 - speed setting 49, 66
- zoom main unit 15, 61
 - operating 61
- zoom socket 62
- zoom unit 13

9. Technical Data

Description of System Components

Controlled Lens Motor	CLM-1
Controlled Lens Motor (small)	CLM-2
Universal Motor Controller for CLM-2 and radio control	UMC-1
Universal Radio Module	URM-1
Wireless Main Unit	WMU-1
Wireless Battery Unit	WBU-1/WBU-2
Wireless Accumulator Charger ..	WAC-1
Wireless Zoom Unit	WZU-1
Wireless Focus Unit	WFU-1
Wireless Extension Unit	WEU-1
Zoom Main Unit	ZMU-1
Focus Iris Unit	FIU-1
Power Cable for CLM-1	LC-S1
Iris Control Unit	ICU-1

Power Supply

Voltage:	24V DC or 12V DC (reduced speed)
Power consumption without motor running:	24V/12V
Motor Unit CLM-1:	0.09/0.15 A
Motor Unit CLM-2:	0.01/0.01 A
Universal Motor Controller UMC-1: .	0.06/0.08 A
Power consumption WMU-1:	0.35 A
Battery WBU-1/WBU-2 for WMU-1:	6 nickel metal hydride cells 7.2V 2 Ah
Zoom Unit:	0.08/0.13 A
Focus-Iris Unit:	0.10/0.10 A
Power Cable LC-S1:	0.04/0.04 A
LCS with 1 Motor Unit CLM-1 operating at full torque:	1.60/1.90A
LCS with 1 UMC-1 and 1 CLM-2 operating at full torque:	0.90/0.90 A

Torque of Motor Unit

Maximum torque on CLM-1 drive gear: 1 Nm
 on CLM-2 drive gear: 0.65 Nm

Maximum speed of the CLM-1
 drive gear at 24V DC: 2 U/s at 0.25 Nm

Maximum speed of the CLM-2
 drive gear at 24V DC: 1 U/s at 0.25 Nm
 2 U/s at 0.15 Nm

Adjustment range on drive gear: .. 8 revolutions

Accuracy of adjustments: max. 1/2 thickness of lens barrel witness marks

Weight

Motor Unit CLM-1 0.63 kg / 1.38 lb
 Motor Unit CLM-2 0.28 kg / 0.61 lb
 Console for CLM-2 0.07 kg / 0.15 lb
 Universal Motor Controller UMC-1 .. 0.28 kg / 0.61 lb
 Universal Radio Module URM-1 ... 0.2 kg / 0.44 lb
 Wireless Main Unit WMU-1 0.4 kg / 0.88 lb
 Battery WBU-1/WBU-2 0.25 kg / 0.55lb
 Wireless Zoom Unit WZU-1 0.17 kg / 0.37 lb
 Wireless Focus Iris Unit WFU-1 ... 0.3 kg / 0.64 lb
 Zoom Main Unit ZMU-1 0.42 kg / 0.92 lb
 Focus Iris Unit FIU-1 0.49 kg / 1.08 lb
 Power Cable LC-S1 0.09 kg / 0.19 lb
 Iris Control Unit ICU-1 0.4 kg / 0.88 lb

Operating Noise Level

Noise level according to DIN 45635/51 for drive gear of motor unit CLM-1

n < 0.5 U/s < 20 dBA

n < 1 U/s < 25 dBA

Motor unit CLM-2

n < 0.5 U/s < 22.5 dBA

Temperature Range

Operating temperature: - 20...50°C (-5° to 122° Fahrenheit)

Storage temperature: - 40...50°C (-40° to 122° Fahrenheit)

Memory Module

Recording time in seconds for:

Number of units	1	2	3
Range 1, 2 separate	242	162	81
Range 1+2 together	485	242	162

Trigger voltage required

between TRIG+ and TRIG-

when open: +4.5 V DC

Allowable voltage range

between TRIG+ and TRIG-: -5 ... +30V DC

Minimal pulse duration for trigger: .. 0.2 s

Iris Control Unit ICU-1

Valid iris range: Will not exceed mechanical end stops of lens
after calibration

Resolution (smallest change): 0.25° (of a typical prime lens iris ring)

Deviation from set iris value: - during constant speed: 1%

- during ramp up/down: 6%

Precision of iris setting: Equals precision of the LCS lens motor

Camera frame rate: 3 to 200 fps (depending on camera model)

Maximum fps change rate: See chapter 5.4 "fps change rate"

10. ARRI Service

Germany Arnold & Richter Cine Technik
 Türkenstraße 89
 D-80799 München
 phone: (089) 3809-0
 fax: (089) 3809-1244
 fax service: (089) 3809-1793
 e-mail service: KDenk@arri.de

USA ARRI USA
 617, Route 303
 Blauvelt, New York 10913
 phone: (914) 353 14 00
 fax: (914) 425 12 50
 e-mail: arriflex@arri.com

ARRI USA
 600 North Victory Blvd.
 Burbank, California 91502
 phone: (818) 841 70 70
 fax: (818) 848 40 28
 e-mail: arriflex@arri.com

GB ARRI (GB) Ltd.
 The Movie House
 1-3 Airlinks, Spitfire Way
 Heston TW5 9 NR
 phone: (0208) 848 88 81
 fax: (0208) 561 13 12
 e-mail: sales@arri-gb.com

Italy ARRI ITALIA S.R.L.
 Viale Edison 318
 20099 Sesto S. Giovanni (Milano),
 Milano
 phone: (02) 26 22 71 75
 fax: (02) 242 16 92
 e-mail: info@arri.it

ARRI ITALIA S.R.L.
 Via Placanica, 97
 00040 Morena (Roma)
 phone: (06) 79 89 02 02
 fax: (06) 79 89 02 39

Canada ARRI Canada Ltd.
 415 Horner Avenue, Unit 11
 Etobicoke, Ontario
 Canada M8W 4W3
 phone: (416) 255 33 35
 fax: (416) 255 33 99
 e-mail: service@arrican.com

Selection of the handcontrol units

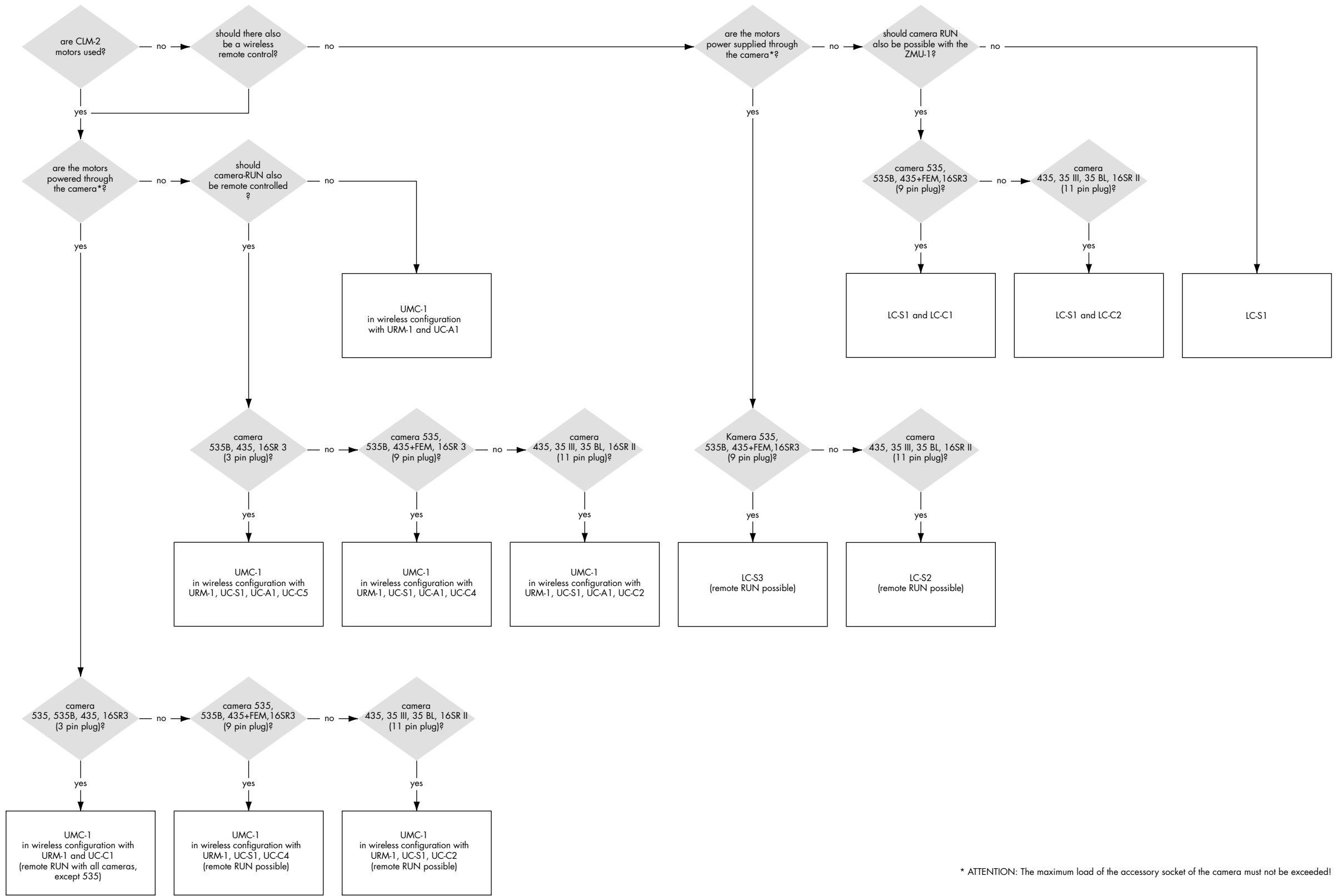

* ATTENTION: The maximum load of the accessory socket of the camera must not be exceeded!

Technical data are subject to change without notice.

© ARRI 2000

Ident. No. K5.52423.0

available languages

Deutsch

English



ARNOLD & RICHTER CINE TECHNIK

TÜRKENSTR. 89 • D-80799 MÜNCHEN • TEL. (089) 3809-0
FAX (089) 3809 - 1244 • <http://www.arri.de>